



SAFETY PRODUCTS
GLOBAL

slice

KLEVER

PHC
PACIFIC HANDY CUTTER

ALWAYS A CUT ABOVE



PROFESSIONAL SAFETY KNIVES

WHY SAFETY KNIVES?

40.000

Source: DGUV2022

DID YOU KNOW HOW MANY REPORTABLE ACCIDENTS AT WORK WITH KNIVES HAPPEN EVERY YEAR IN GERMANY?

Hands, arms and legs are particularly affected by cut injuries. On top of this the damage to goods caused by the use of knives can hardly be quantified. That's why you want to cut safely and at the same time protect your goods!

With us you will find every level of security:

- Safety knives with finger friendly ceramic blades
- Safety knives with concealed blades
- Safety knives with fully automatic blade retraction (smart)
- Safety knives with protective hood
- Safety knives with automatic blade retraction
- Safety knives with squeeze grip
- Eco safety knives with pre-consumer recycled content

But even beyond that, many of our safety knives are about intelligent details:

- Attractive hi-vis colours, often several choices per knife.
- Knives with interchangeable and different blade heads: "Keep the handle, replace the head!".
- Integrated tape splitter: protects your blade, and is also safer to use.
- Safety knives with blade guards, that also act as a cutting guide.
- Replacement blade controls: simply practical.
- Adjustable blade lengths: So you protect packaged material even better!
- Multi-purpose safety knives, with both open and concealed blades. For those who have to be able to do everything!

SAFETY PRODUCTS
GLOBAL

slice **KLEVER.** **PHC**
PACIFIC HANDY CUTTER

PACIFIC HANDY CUTTER, our oldest brand, has been producing safe cutting solutions since 1950. This experience makes us a globally leading manufacturer and supplier of safety knives.

KLEVER is our concealed blade specialist and global leader in this sector.

SLICE: unique and Finger Friendly. Market leading ceramic brand.

This experience makes us a globally leading manufacturer. With our portfolio of brands, we offer safe cutting solutions for almost all applications in almost every industry. Who could give you more choice? In our own plants in California and Michigan we manufacture not only safety knives but also blades. In house manufacturing ensures the highest quality standards.

For more information, visit:

www.safetyproductsholdings.com or our brand websites www.eu.sliceproducts.com, www.kleverinnovations.net and www.phcsafety.com

We are convinced by the safety, variety and quality of our products and services, and we want to convince you too! Just call or e-mail if you need further information.

WHAT DO WE OFFER?

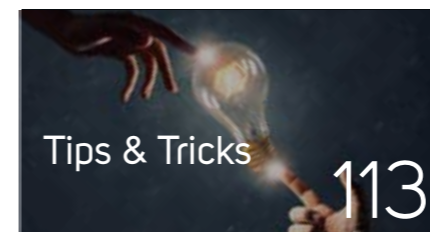
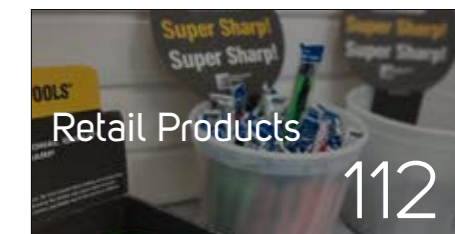
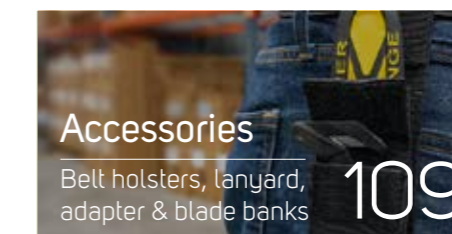
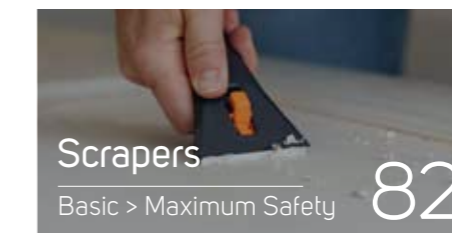
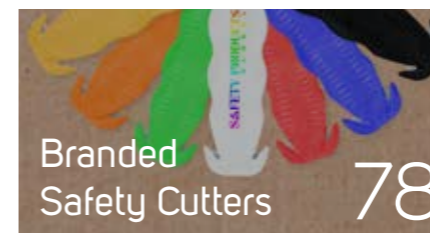
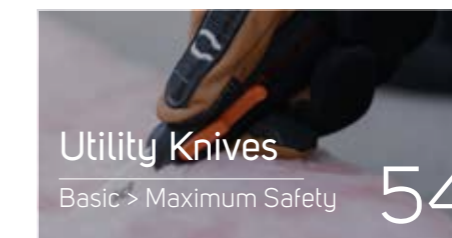
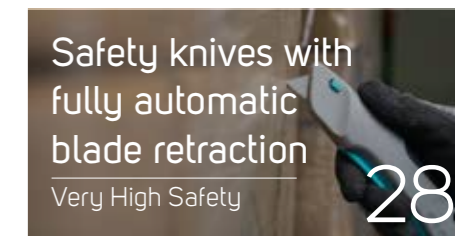
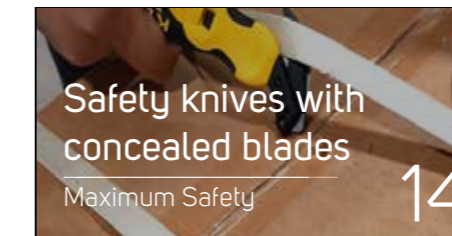

Safety Products Global or SPG is a global leader in the design and manufacture of safety knives. The group consists of three leading brands, each with its own USP.

This portfolio of brands, and safety knife products allows us to support almost all safe cutting applications. A tailored approach that equips users with the correct safe cutting tool for the job at hand.



There are ceramic blades and then there is SLICE! The only Finger Friendly safety blade in the market. The combination of hard-wearing zirconium oxide material, together with our Finger Friendly grind, makes SLICE blades last up to 11x longer than traditional blades. Combine these blades with our huge variety of innovative, ergonomic SLICE handles and enjoy the highest level of safety available in an open blade safety knife.

More reasons to use SLICE: Non-magnetic, non-conductive, non-sparking, safe up to 1600 degrees Celsius, chemically inert and non-contaminating, non-reactive: impervious to acids and salt, non-porous and chemically resistant, oil and lubricant free, never rusts.



The market leader in enclosed blade safety knives, KLEVER has set the standard since the original KLEVER Cutter hit the market. Manufactured in our state-of-the-art facility in Michigan, USA. KLEVER boasts an impressive portfolio of enclosed blade safety knives that are popular the world over. The KLEVER XCHANGE, KLEVER KUTTER and our range of ECO products made from high percentages of pre-consumer recycled plastic lead the way in the sector. Ever growing in popularity.

Add to this our new Smooth Kut XD heads and you will see why KLEVER is so popular.



Our original, founding brand Pacific Handy Cutter or PHC dates back to 1950, when Herbert Lightburn designed and made the original Handy Cutter. Things have developed a little since then its fair to say! PHC manufactures steel blades in our California HQ. Utilising these blades in safety knife handles, with different intelligent safety mechanisms. Smart-Retract, or fully automatic, Auto-Retract or automatic blade retraction mechanisms are designed for user safety, alongside other features that also protect the goods contained in the packaging being opened.

WHY SLICE?

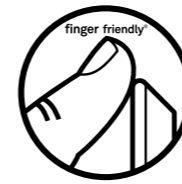

Why is a SLICE blade different from other blades? It's our unique, Finger Friendly grind that sets us apart. Not just from steel blades, but other ceramic blades too. Due to this special grind, SLICE blades cut nearly all materials but are much safer to the touch.

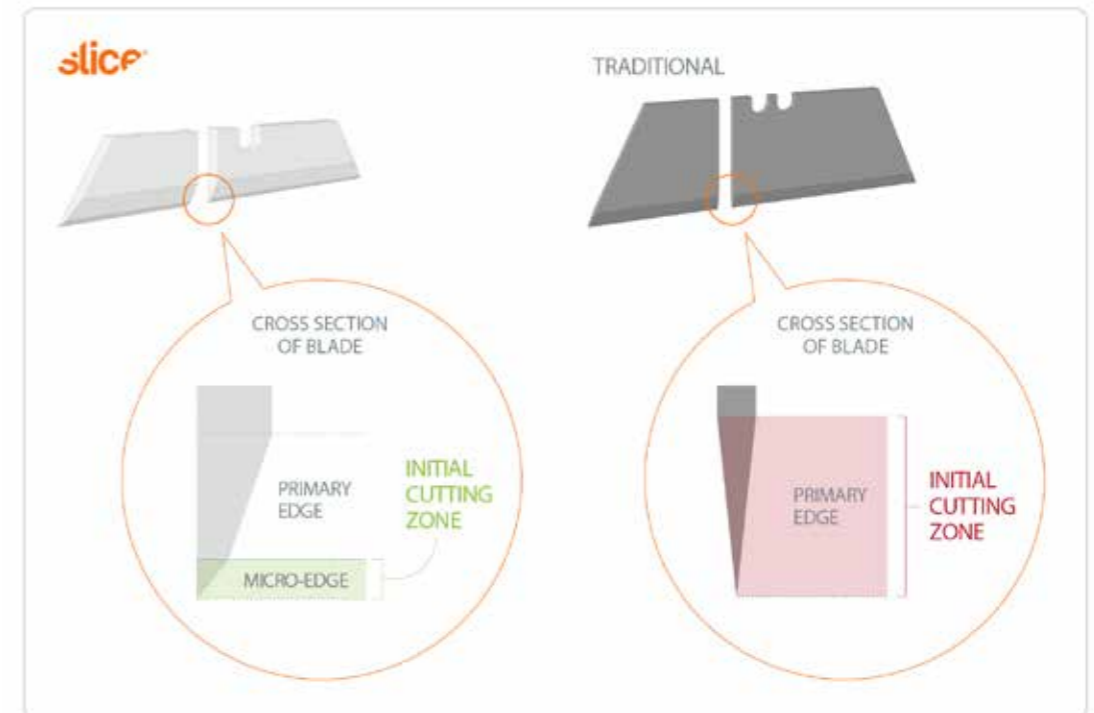

Made from hard wearing Zirconium Oxide, SLICE blades last up to 11x longer than conventional blades. When you couple that with the Finger Friendly grind and all of the other properties that come with a SLICE blade, you've found an unrivalled excellence in safe cutting.

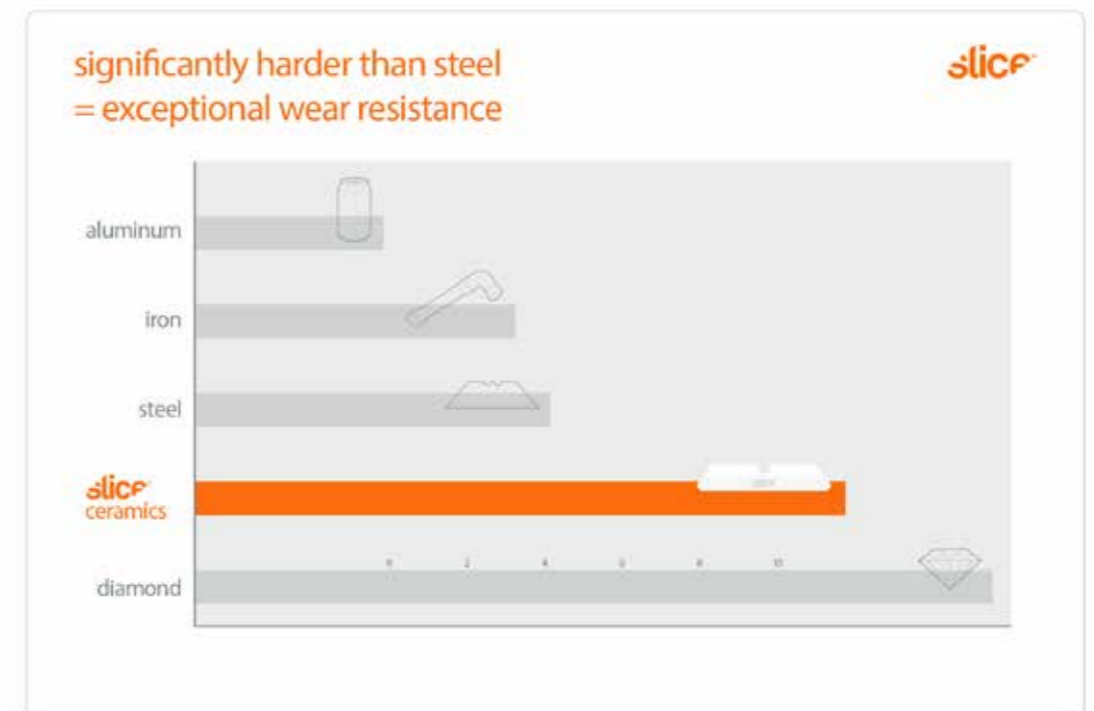

KLEVER.XD

ENHANCE YOUR CUTTING EXPERIENCE SUBSTANTIALLY

ENGINEERED FOR EXTRA STRENGTH

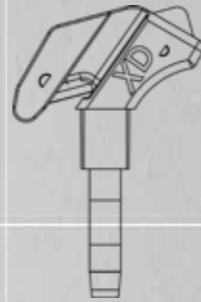

**50% STRONGER &
LASTS UP TO 4X
LONGER**

Thickened reinforced plastic in high friction stress points making the blade 50% stronger and lasts up to 4 times longer than other safety cutters.

PROPRIETARY SMOOTH-KUT™ TECHNOLOGY



Prevents corrugate from clogging in the blade for faster, smoother, and more ergonomic cutting.

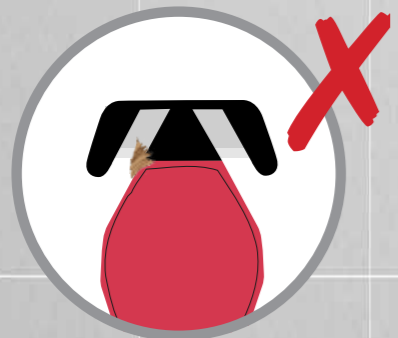

Clogged blades reduce operator cutting speed and introduce risk of injury when removing corrugate.

ECO SAFETY KNIVES

Protecting people, products & our planet



ECO-200XC-20EX



ECO-4-65EX



ECO-1-E



Our new range of safety knives made from pre-consumer recycled plastic content.

Independently certified.

KLEVER ECO KUTTER

75% RECYCLED PLASTIC

The KLEVER ECO KUTTER is our all-rounder made with 75% pre-consumer recycled plastics. Support your ESG goals with your safety knife. Small, handy, versatile, and especially safe! Maximum level of safety, protecting users and goods at the same time. Double blade head, so particularly economical. Disposable. Ideal for single-wall corrugated, cardboard, foil, adhesive tape, delivery note bags, strapping tape, paper, string, etc. With practical eyelet for lanyard fastening or hanging. Also available in standard, KLEEN, NSF and MDP, see page 14, 66, 71 and 74.



ATTRIBUTES

Safety Maximum Safety

Blade Access 3 mm

Cutting Materials

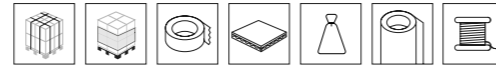



Other Features



PRODUCT DETAILS

Model	KLEVER ECO KUTTER KJC-1K
PRODUCT CODES	KCJ-1K
Recycled Pre-consumer Content	75%
Dimensions LxWxH	119 x 33 x 4 mm
Weight	16 g
Would you like to print on me?	It's Possible! See page 78
Available in	1 Inner Bag of 10 1 Master Carton of 1000

ACCESSORIES

	Belt Holster: KLEVER KCJ-HOL, For further information please see page 110
	Lanyard: CL-36 For further information please see page 109

KLEVER ECO EXCEL XD

100% RECYCLED HANDLE

Eco Excel XD features our proprietary Smooth-Kut technology, preventing clogging of the blade for faster, smoother cutting. The handle is made from 100% pre-consumer recycled plastic and sits comfortably in the hand due to its rounded shape. The XD blade head is 50% stronger and lasts up to 4X longer. The disposable knife offers an integrated tape splitter, the application of which minimises the use of the blade. Ideal for up to 2-wall corrugated, cardboard, pallet wrap and banding. With eyelet for attaching lanyard or hanging.



ATTRIBUTES

Safety Maximum Safety

Blade Access 5 mm

Cutting Materials

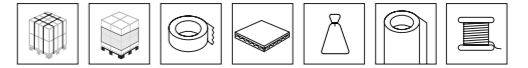

Other Features





XD



PRODUCT DETAILS

Model	KLEVER ECO EXCEL XD ECO-4-65EX
PRODUCT CODES	ECO-4-65EX
Recycled Pre-consumer Content	Handle: 100%
Dimensions LxWxH	178 x 45 x 8 mm
Weight	31 g
Would you like to print on me?	It's Possible! See page 78
Available in	1 Inner Bag of 10 1 Master Carton of 100

ACCESSORIES

	Belt Holster: KLEVER KCJ-HOL For further information please see page 110
	Lanyard: CL-36 For further information please see page 109

KLEVER ECO XCHANGE 20

100% RECYCLED HANDLE

Are you looking for a sustainable all-round talent with great variety and maximum safety, but still want a particularly economical solution? Then you will love the KLEVER ECO XCHANGE 20 safety knife! It offers a stable and ergonomic grip as well as multiple support surfaces for your thumb. The reusable knife handle is made from 100% pre-consumer recycled plastic. The double blade head makes the knife particularly economical. "Keep the handle, replace the head!" The blades are concealed to protect the user and material, plus the blade heads are very easy to replace. The KLEVER ECO XCHANGE 20 is ideal for up to 1.5 wall corrugated, cardboard, strapping, adhesive tape, string, bagged goods, felt, textiles, etc. With integrated tape splitter and practical lanyard eyelet. Can also be combined with any of our four replacement blade heads.



ATTRIBUTES

Safety Maximum Safety

Blade Access 6 mm

Cutting Materials

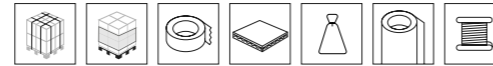

Other Features

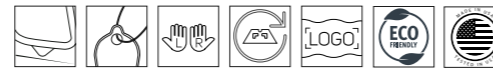

PRODUCT DETAILS

Model	KLEVER ECO XCHANGE 20 ECO-200XC-20EX
PRODUCT CODES	ECO-200XC-20EX
Recycled Pre-consumer Content	Handle: 100%
Dimensions LxWxH	166 x 33 x 8 mm
Weight	21 g
Available in	1 Inner Bag of 10 1 Master Carton of 100

ACCESSORIES



MOUNTED BLADE

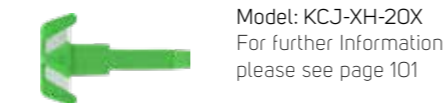

OPTIONAL BLADES

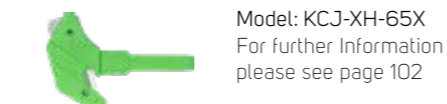
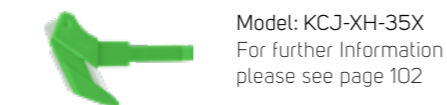
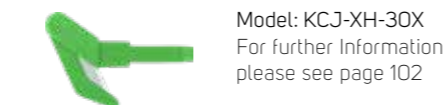

KLEVER ECO XCHANGE 30

100% RECYCLED HANDLE

Are you looking for a sustainable all-round talent with great variety and maximum safety, but still want a particularly economical solution? Then you will love the KLEVER ECO XCHANGE 30 safety knife! It offers a stable and ergonomic grip as well as multiple support surfaces for your thumb. The reusable knife handle is made from 100% pre-consumer recycled plastic. The wide blade head allows for thicker cutting. "Keep the handle, replace the head!" The blades are concealed to protect the user and material, plus the blade heads are very easy to replace. The KLEVER ECO XCHANGE 30 is ideal for up to 2 wall corrugated, cardboard, strapping, adhesive tape, string, bagged goods, felt, textiles, etc. With integrated tape splitter and practical lanyard eyelet. Can also be combined with any of our four replacement blade heads.



ATTRIBUTES

Safety Maximum Safety

Blade Access 8 mm

Cutting Materials

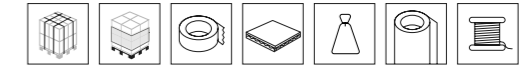

Other Features



PRODUCT DETAILS

Model	KLEVER ECO XCHANGE 30 ECO-200XC-30EX
PRODUCT CODES	ECO-200XC-30EX
Recycled Pre-consumer Content	Handle: 100%
Dimensions LxWxH	178 x 45 x 8 mm
Weight	24 g
Available in	1 Inner Bag of 10 1 Master Carton of 100

ACCESSORIES

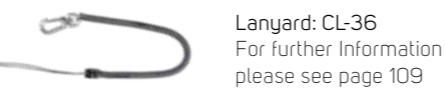

MOUNTED BLADE

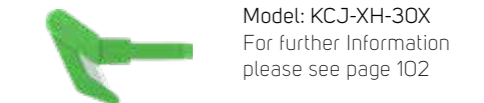

OPTIONAL BLADES

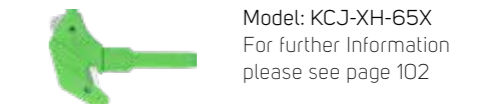
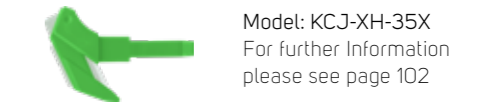
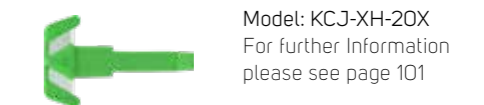

KLEVER ECO XCHANGE 35

100% RECYCLED HANDLE

Are you looking for a sustainable all-round talent with great variety and maximum safety, but still want a particularly economical solution? Then you will love the KLEVER ECO XCHANGE 35 safety knife! It offers a stable and ergonomic grip as well as multiple support surfaces for your thumb. The reusable knife handle is made from 100% pre-consumer recycled plastic. The wide blade head allows for thicker cutting and includes a scraper. "Keep the handle, replace the head!" The blades are concealed to protect the user and material, plus the blade heads are very easy to replace. The KLEVER ECO XCHANGE 35 is ideal for up to 2 wall corrugated, cardboard, strapping, adhesive tape, string, bagged goods, felt, textiles, etc. With integrated tape splitter and practical lanyard eyelet. Can also be combined with any of our four replacement blade heads.



ATTRIBUTES

Safety Maximum Safety

Blade Access 8 mm

Cutting Materials

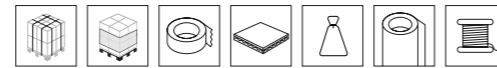

Other Features

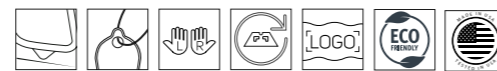

PRODUCT DETAILS

Model	KLEVER ECO XCHANGE 35 ECO-200XC-35EX
PRODUCT CODES	ECO-200XC-35EX
Pre-consumer Content	Handle: 100%
Dimensions LxWxH	180 x 45 x 8 mm
Weight	25 g
Available in	1 Inner Bag of 10 1 Master Carton of 100

ACCESSORIES



Belt Holster:
KLEVER KCJ-HOL
For further Information
please see page 110



Lanyard: CL-36
For further Information
please see page 109

MOUNTED BLADE



Model: KCJ-XH-35X
For further Information
please see page 102

OPTIONAL BLADES



Model: KCJ-XH-20X
For further Information
please see page 101



Model: KCJ-XH-30X
For further Information
please see page 102



Model: KCJ-XH-65X
For further Information
please see page 102

KLEVER ECO XCHANGE 65

100% RECYCLED HANDLE

Are you looking for a sustainable all-round talent with great variety and maximum safety, but still want a particularly economical solution? Then you will love the KLEVER ECO XCHANGE 65 safety knife! It offers a stable and ergonomic grip as well as multiple support surfaces for your thumb. The reusable knife handle is made from 100% pre-consumer recycled plastic. The XD Smooth-Kut blade head is 50% stronger and lasts up to 4 X longer. "Keep the handle, replace the head!" The blades are concealed to protect the user and material, plus the blade heads are very easy to replace. The KLEVER ECO XCHANGE 65 is ideal for up to 2 wall corrugated, cardboard, strapping, adhesive tape, string, bagged goods, felt, textiles, etc. With integrated tape splitter and practical lanyard eyelet. Can also be combined with any of our four replacement blade heads.



ATTRIBUTES

Safety Maximum Safety

Blade Access 5 mm

Cutting Materials

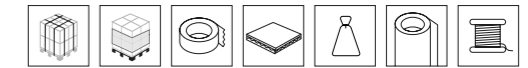

Other Features

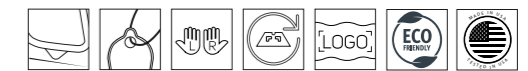

PRODUCT DETAILS

Model	KLEVER ECO XCHANGE 65 ECO-200XC-65EX
PRODUCT CODES	ECO-200XC-65EX
Pre-consumer Content	Handle: 100%
Dimensions LxWxH	178 x 45 x 8 mm
Weight	26 g
Available in	1 Inner Bag of 10 1 Master Carton of 100

ACCESSORIES



Belt Holster:
KLEVER KCJ-HOL
For further Information
please see page 110



Lanyard: CL-36
For further Information
please see page 109

MOUNTED BLADE



Model: KCJ-XH-65X
For further Information
please see page 102

OPTIONAL BLADES



Model: KCJ-XH-20X
For further Information
please see page 101



Model: KCJ-XH-30X
For further Information
please see page 102



Model: KCJ-XH-35X
For further Information
please see page 102

KLEVER KUTTER

6 COLOUR CHOICES

The KLEVER KUTTER is our all-rounder! And the forerunner of all safety cutters with a concealed blade! Small, handy, versatile, and especially safe! Highest level of safety, protecting users and goods at the same time. Double blade head, so particularly economical. Disposable. Here in bright yellow. Wide range of colours available, including many hi-vis colours. This makes your safety knife always easy to find. Ideal for single-wall corrugated, cardboard, foil, adhesive tape, delivery note bags, strapping tape, paper, string, etc. With practical eyelet for lanyard fastening or hanging. Also available in ECO, KLEEN, NSF and MDP. See pages, 8, 66, 71 and 74.

ATTRIBUTES

Safety	Maximum Safety
--------	----------------

Blade Access	3 mm
--------------	------

Cutting Materials

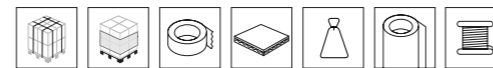

Other Features



PRODUCT DETAILS

Model	KLEVER KUTTER KCJ-1
PRODUCT CODES	KCJ-1 + COLOUR
Colours	
Dimensions LxWxH	119 x 33 x 4 mm
Weight	16 g
Would you like to print on me?	It's Possible! See page 78
Available in	1 Inner Bag of 10 1 Master Carton of 1000

ACCESSORIES

	Belt Holster: KLEVER KCJ-HOL For further Information please see page 110
	Lanyard: CL-36 For further Information please see page 109

KLEVER KONCEPT

INTEGRAL TAPE SPLITTER

The KLEVER KONCEPT with a concealed blade! Ergonomic handle and the cousin of the KLEVER Kutter, so especially safe! Highest level of safety, protecting users and goods at the same time. Double blade head, so particularly economical. Disposable. Here in bright yellow. Four bright colours available. This makes your safety knife always easy to find. Ideal for single-wave corrugated, cardboard, foil, adhesive tape, delivery note bags, strapping tape, paper, string, etc. With practical eyelet for lanyard fastening or hanging and an integral tape splitter.

ATTRIBUTES

Safety	Maximum Safety
--------	----------------

Blade Access	4 mm
--------------	------

Cutting Materials

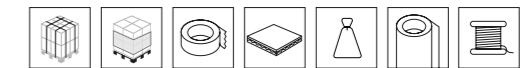

Other Features



PRODUCT DETAILS

Model	KLEVER KONCEPT KCJ-2
PRODUCT CODES	KCJ-2 + COLOUR
Colours	
Dimensions LxWxH	145 x 36 x 10 mm
Weight	17 g
Would you like to print on me?	It's Possible! See page 78
Available in	1 Inner Bag of 10 1 Master Carton of 500

ACCESSORIES

	Belt Holster: KLEVER KCJ-HOL For further Information please see page 110
	Lanyard: CL-36 For further Information please see page 109

KLEVER EXCEL 20

DOUBLE HEAD

Do you need a safety knife of the maximum safety level, but want a little more "grip"? Then choose the KLEVER EXCEL 20 safety knife with concealed blade. The large handle sits comfortably in the hand due to its rounded shape and also offers your thumb a comfortable position. Double blade head, therefore particularly economical. The disposable knife offers an integrated tape splitter, the application of which minimises the use of the blade. Ideal for up to 1.5-wall corrugated, cardboard, foil, adhesive tape and banding. Here in striking yellow. Other colours available. With eyelet for attaching lanyard or hanging.



ATTRIBUTES

Safety	Maximum Safety
Blade Access	6 mm

Cutting Materials

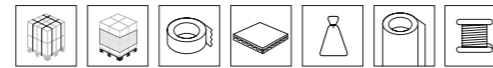

Other Features



PRODUCT DETAILS

Model	KLEVER EXCEL KCJ-4-20
PRODUCT CODES	KCJ-4-20 + COLOUR
Colours	
Dimensions LxWxH	165 x 35 x 8 mm
Weight	27 g
Would you like to print on me?	It's Possible! See page 78
Available in	1 Inner Bag of 10 1 Master Carton of 500

ACCESSORIES

	Belt Holster: KLEVER KCJ-HOL For further Information please see page 110
	Lanyard: CL-36 For further Information please see page 109

KLEVER EXCEL 30

WIDE HEAD

Do you need a safety knife of the maximum safety level, but want a little more "grip"? Then choose the KLEVER EXCEL 30 safety knife with concealed blade. The large handle sits comfortably in the hand due to its rounded shape and also offers your thumb a comfortable position. Due to the wider blade head, even thicker material can be cut easily and safely. The disposable knife offers an integrated tape splitter, the application of which minimises the use of the blade. Ideal for up to 2-wall corrugated, cardboard, foil, adhesive tape and banding. Here in striking yellow. Other colours available. With eyelet for attaching lanyard or hanging.



ATTRIBUTES

Safety	Maximum Safety
Blade Access	8 mm

Cutting Materials

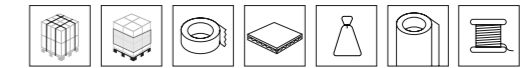

Other Features



PRODUCT DETAILS

Model	KLEVER EXCEL KCJ-4-30
PRODUCT CODES	KCJ-4-30 + COLOUR
Colours	
Dimensions LxWxH	177 x 43 x 8 mm
Weight	31 g
Would you like to print on me?	It's Possible! See page 78
Available in	1 Inner Bag of 10 1 Master Carton of 500

ACCESSORIES

	Belt Holster: KLEVER KCJ-HOL For further Information please see page 110
	Lanyard: CL-36 For further Information please see page 109

EBC1

INTEGRAL TAPE SPLITTER



The EBC1 is a particularly robust safety knife with a concealed blade. Therefore, it is particularly safe. It is perfect for cutting up to double-wall corrugated cardboard, strapping and many other materials. A disposable product in hi-vis yellow. With practical tape splitter to minimise blade use and product damage. Plus an eyelet for fastening a lanyard or hanging. Do you need to cut to a greater distance? Then you will like our adapter DFCCON. This turns your EBC1 into a telescopic cutting tool!

ATTRIBUTES

Safety	Maximum Safety
Blade Access	6 mm

Cutting Materials

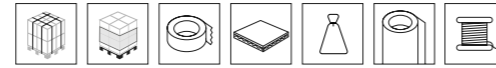



Other Features



PRODUCT DETAILS

Model	EBC1
PRODUCT CODES	EBC1
Dimensions LxWxH	159 x 47 x 10 mm
Weight	23 g
Available in	1 Inner Bag of 50 1 Master Carton of 300

ACCESSORIES

	Lanyard: CL-36 For further Information please see page 109
	Adapter: DFCCON For further Information please see page 109

DFC-364

FILM CUTTER



The DFC364 is a safety cutter with a concealed blade. It offers the maximum level of security and thus protects people and goods at the same time. Our film specialist - particularly suitable for puncturing due to the long nose. Designed for foil of any kind, adhesive tape, strapping and banding. The integrated tape splitter minimises the use of the blade. A disposable product, with practical eyelet for fastening a lanyard or hanging. Do you need to cut to a greater distance? Then you will like our adapter DFCCON. This turns your DFC364 into a telescopic cutting tool.

ATTRIBUTES

Safety	Maximum Safety
Blade Access	4 mm

Cutting Materials

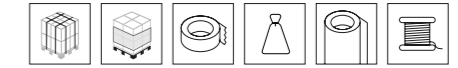



Other Features



PRODUCT DETAILS

Model	DFC-364
PRODUCT CODES	DFC-364
Dimensions LxWxH	168 x 63 x 10 mm
Weight	22 g
Available in	1 Inner Bag of 50 1 Master Carton of 300

ACCESSORIES

	Lanyard: CL-36 For further Information please see page 109
	Adapter: DFCCON For further Information please see page 109

KLEVER XCHANGE 20

KEEP THE HANDLE, CHANGE THE HEAD

Are you looking for maximum safety and maximum comfort? The KLEVER XCHANGE 20 safety knife offers you the highest level of ergonomics: anatomically shaped handle, non-slip soft rubber grip, a variety of contact surfaces for your thumb. The knife handle is reusable in many ways, the double blade head makes the knife particularly economical. "Keep the handle, replace the head!" The blades are concealed and protect the user and material, with added benefit of simple blade change. The KLEVER XCHANGE is ideal for up to 1.5 wall corrugated, cardboard, strapping, adhesive tape, string, bagged goods, felt, textiles, etc. Here in bright yellow, with many other colours available. Integrated tape splitter and practical eyelet for lanyard attachment. The handle can be combined with any of our five replacement blade heads - a real all-rounder!



ATTRIBUTES

Safety Maximum Safety

Blade Access 6 mm

Cutting Materials

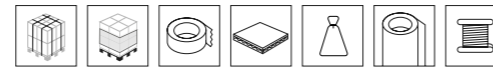

Other Features



PRODUCT DETAILS

Model	KLEVER XCHANGE KCJ-XC-20
PRODUCT CODES	KCJ-XC-20 + COLOUR
Colours	
Dimensions LxWxH	164 x 39 x 10 mm
Weight	34 g
Available in	1 Inner Bag of 12 1 Master Carton of 144

ACCESSORIES

- Belt Holster: KLEVER KCJ-HOL
For further Information please see page 110
- Lanyard: CL-36
For further Information please see page 109

MOUNTED BLADE

- Model: KCJ-XH-20
For further Information please see page 100

OPTIONAL BLADES

- Model: KCJ-XH-30
For further Information please see page 100
- Model: KCJ-XH-35
For further Information please see page 100
- Model: KCJ-XH-40
For further Information please see page 101
- Model: KCJ-XH-65
For further Information please see page 101

KLEVER XCHANGE 30

KEEP THE HANDLE, CHANGE THE HEAD

Are you looking for maximum safety and maximum comfort? The KLEVER XCHANGE 30 safety knife offers you the highest level of ergonomics: anatomically shaped handle, non-slip soft rubber grip, a variety of contact surfaces for your thumb. The knife handle is reusable in many ways. "Keep the handle, replace the head!" The blades are concealed and protect the user and material, with added benefit of simple blade change. Due to the wider blade access, the KLEVER XCHANGE 30 is ideally suited for up to 2-wall corrugated, cardboard, strapping, adhesive tape, string, bagged goods, felt, textiles, etc. Here in bright yellow. Many other colours available. With integrated tape splitter and practical lanyard eyelet. The handle can be combined with any of our five replacement blade heads - a real all-rounder!



ATTRIBUTES

Safety Maximum Safety

Blade Access 8 mm

Cutting Materials

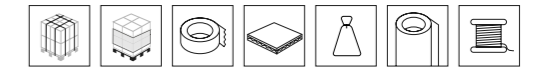

Other Features

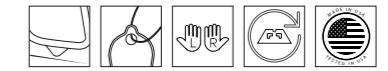

PRODUCT DETAILS

Model	KLEVER XCHANGE KCJ-XC-30
PRODUCT CODES	KCJ-XC-30 + COLOUR
Colours	
Dimensions LxWxH	176 x 49 x 10 mm
Weight	37 g
Available in	1 Inner Bag of 12 1 Master Carton of 144

ACCESSORIES

- Belt Holster: KLEVER KCJ-HOL
For further Information please see page 110
- Lanyard: CL-36
For further Information please see page 109

MOUNTED BLADE

- Model: KCJ-XH-30
For further Information please see page 100

OPTIONAL BLADES

- Model: KCJ-XH-20
For further Information please see page 100
- Model: KCJ-XH-35
For further Information please see page 100
- Model: KCJ-XH-40
For further Information please see page 101
- Model: KCJ-XH-65
For further Information please see page 101

KLEVER XCHANGE 35

KEEP THE HANDLE, CHANGE THE HEAD

Are you looking for maximum safety and maximum comfort? The KLEVER XCHANGE 35 safety knife offers you the highest level of ergonomics: anatomically shaped handle, non-slip soft rubber grip, a variety of contact surfaces for your thumb. The knife handle is reusable in many ways. "Keep the handle, replace the head!" The blades are concealed and protect the user and material, with added benefit of simple blade change. Due to the wider blade access, the KLEVER XCHANGE 35 is ideally suited for up to 2-wall corrugated, cardboard, strapping, adhesive tape, string, bagged goods, felt, textiles, etc. Here in bright yellow. Many other colours available. With integrated scraper and tape splitter, plus practical lanyard eyelet. The handle can be combined with any of our five replacement blade heads - a real all-rounder!



ATTRIBUTES

Safety	Maximum Safety
Blade Access	8 mm
Cutting Materials	
Other Features	



PRODUCT DETAILS

Model	KLEVER XCHANGE KCJ-XC-35
PRODUCT CODES	KCJ-XC-35 + COLOUR
Colours	
Dimensions LxWxH	176 x 49 x 10 mm
Weight	37 g
Available in	1 Inner Bag of 12 1 Master Carton of 144

ACCESSORIES

	Belt Holster: KLEVER KCJ-HOL For further Information please see page 110
	Lanyard: CL-36 For further Information please see page 109

MOUNTED BLADE

	Model: KCJ-XH-35 For further Information please see page 100
--	--

OPTIONAL BLADES

	Model: KCJ-XH-20 For further Information please see page 100
	Model: KCJ-XH-30 For further Information please see page 100
	Model: KCJ-XH-40 For further Information please see page 101
	Model: KCJ-XH-65 For further Information please see page 101

KLEVER XCHANGE 65

KEEP THE HANDLE, CHANGE THE HEAD

The KLEVER XCHANGE 65 safety knife offers you the highest level of ergonomics: anatomically shaped handle, non-slip soft rubber grip, a variety of contact surfaces for your thumb. The knife handle is reusable in many ways. "Keep the handle, replace the head!" The blades are concealed and protect the user and material, with added benefit of simple blade change. Featuring our XD blade head with Smooth Kut, the KLEVER XCHANGE 65 is ideally suited for 2-wall corrugated, cardboard, strapping, adhesive tape, string, bagged goods, felt, textiles, etc. Here in bright yellow. Many other colours available. With integrated tape splitter, plus practical lanyard eyelet. The handle can be combined with any of our five replacement blade heads - a real all-rounder!



ATTRIBUTES

Safety	Maximum Safety
Blade Access	5 mm
Cutting Materials	
Other Features	



PRODUCT DETAILS

Model	KLEVER XCHANGE KCJ-XC-65
PRODUCT CODES	KCJ-XC-65 + COLOUR
Colours	
Dimensions LxWxH	178 x 45 x 10 mm
Weight	39 g
Available in	1 Inner Bag of 12 1 Master Carton of 144

ACCESSORIES

	Belt Holster: KLEVER KCJ-HOL For further Information please see page 110
	Lanyard: CL-36 For further Information please see page 109

MOUNTED BLADE

	Model: KCJ-XH-65 For further Information please see page 101
--	--

OPTIONAL BLADES

	Model: KCJ-XH-20 For further Information please see page 100
	Model: KCJ-XH-30 For further Information please see page 100
	Model: KCJ-XH-35 For further Information please see page 100
	Model: KCJ-XH-40 For further Information please see page 101

KLEVER XCHANGE PLUS 20

CHOICE OF FIVE CUTTING HEADS

Are you looking for a sustainable all-round talent with great variety and maximum safety, but still want a particularly economical solution? Then you will love the KLEVER XCHANGE PLUS 20 safety knife! It offers a stable and ergonomic grip as well as multiple support surfaces for your thumb. The knife handle is reusable in many ways, the double blade head makes the knife particularly economical. "Keep the handle, replace the head!" The blades are concealed to protect the user and material, plus the blade heads are very easy to replace. The KLEVER XCHANGE PLUS 20 is ideal for up to 1.5 wall corrugated, cardboard, strapping, adhesive tape, string, bagged goods, felt, textiles, etc. Here in bright yellow. Many other colours available. With integrated tape splitter and practical lanyard eyelet. Can also be combined with any of our five replacement blade heads - a real talent!



ATTRIBUTES

Safety Maximum Safety

Blade Access 6 mm

Cutting Materials

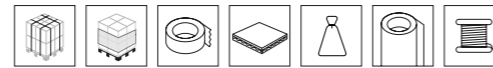

Other Features



PRODUCT DETAILS

Model	KLEVER XCHANGE PLUS PLS-200XC-20
PRODUCT CODES	PLS-200XC-20 + COLOUR
Colours	
Dimensions LxWxH	166 x 33 x 8 mm
Weight	27 g
Available in	1 Inner Bag of 10 1 Master Carton of 500

ACCESSORIES

- Belt Holster: KLEVER KCJ-HOL For further Information please see page 110
- Lanyard: CL-36 For further Information please see page 109

MOUNTED BLADE

- Model: KCJ-XH-20 For further Information please see page 100

OPTIONAL BLADES

- Model: KCJ-XH-30 For further Information please see page 100
- Model: KCJ-XH-35 For further Information please see page 100
- Model: KCJ-XH-40 For further Information please see page 101
- Model: KCJ-XH-65 For further Information please see page 101

KLEVER XCHANGE PLUS 30

CHOICE OF FIVE CUTTING HEADS

Are you looking for a sustainable all-round talent with great variety and maximum safety, but still want a particularly economical solution? Then you will love the KLEVER XCHANGE PLUS 30 safety knife! It offers a stable and ergonomic grip as well as multiple support surfaces for your thumb. The knife handle is reusable in many ways, the wide blade head makes the knife very functional. "Keep the handle, replace the head!" These wider mouth blades are concealed to protect the user and material, plus the blade heads are very easy to replace. The KLEVER XCHANGE PLUS 30 is ideal for up to 2 wall corrugated, cardboard, strapping, adhesive tape, string, bagged goods, felt, textiles, etc. Here in bright yellow. Many other colours available. With integrated tape splitter and practical lanyard eyelet. Can also be combined with any of our five replacement blade heads - a real talent!



ATTRIBUTES

Safety Maximum Safety

Blade Access 8 mm

Cutting Materials

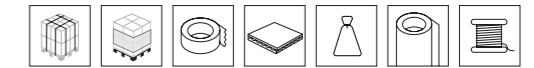

Other Features



PRODUCT DETAILS

Model	KLEVER XCHANGE PLUS PLS-200XC-30
PRODUCT CODES	PLS-200XC-30 + COLOUR
Colours	
Dimensions LxWxH	178 x 33 x 8 mm
Weight	31 g
Available in	1 Inner Bag of 10 1 Master Carton of 500

ACCESSORIES

- Belt Holster: KLEVER KCJ-HOL, UKH-671 For further Information please see page 110
- Lanyard: CL-36 For further Information please see page 109

MOUNTED BLADE

- Model: KCJ-XH-30 For further Information please see page 100

OPTIONAL BLADES

- Model: KCJ-XH-20 For further Information please see page 100
- Model: KCJ-XH-35 For further Information please see page 100
- Model: KCJ-XH-40 For further Information please see page 101
- Model: KCJ-XH-65 For further Information please see page 101

KLEVER XCHANGE PLUS 35

CHOICE OF FIVE CUTTING HEADS

Are you looking for a sustainable all-round talent with great diversity and maximum safety and still want a special economical solution? Then you will like the safety knife KLEVER XCHANGE PLUS 35! It offers a stable and ergonomic handle as well as several contact surfaces for your thumb. The knife handle is reusable in many ways, the double blade head makes the knife special economical. "Keep the handle, replace the head!" The Blades lie concealed and protect users and material. Furthermore the blade heads are very easy to replace. The KLEVER XCHANGE PLUS 35 is ideal for up to 2 wall corrugated cardboard, strapping, adhesive tape, string, bagged goods, felt, textiles, etc. Here in bright yellow. Thanks to the double tape splitters, on the head and at the end of the handle you never open boxes faster!



ATTRIBUTES

Safety	Maximum Safety
Blade Access	8 mm
Cutting Materials	
Other Features	



PRODUCT DETAILS

Model	KLEVER XCHANGE PLUS PLS-200-35
PRODUCT CODES	PLS-200-35 + COLOUR
Colours	
Dimensions LxWxH	178 x 33 x 8 mm
Weight	31 g
Available in	1 Inner Bag of 10 1 Master Carton of 500

ACCESSORIES

	Belt Holster: KLEVER KCJ-HOL For further Information please see page 110
	Lanyard: CL-36 For further Information please see page 109

MOUNTED BLADE

	Model: KCJ-XH-35 For further Information please see page 100
--	--

OPTIONAL BLADES

	Model: KCJ-XH-20 For further Information please see page 100
	Model: KCJ-XH-30 For further Information please see page 100
	Model: KCJ-XH-40 For further Information please see page 101
	Model: KCJ-XH-65 For further Information please see page 101

EZR

HEAVY DUTY CUTTER



ATTRIBUTES

Safety	Maximum Safety
Blade Access	7 mm
Cutting Materials	
Other Features	

Do you need a safety knife with the maximum safety level, which should also be particularly robust? Do you also attach great importance to great sustainability? The EZR safety knife offers a concealed blade that can be turned first and later replaced individually. Thus, this knife is particularly economical, and you reduce waste to a minimum! The blade cover is made of metal so you can pierce and cut vigorously. With practical belt clip, eyelet for lanyard fastening or hanging and integrated metal tape splitter.



PRODUCT DETAILS

Model	EZR
PRODUCT CODES	EZR
Dimensions LxWxH	163 x 47 x 10 mm
Weight	31 g
Available in	1 Inner Bag of 50 1 Master Carton of 300

MOUNTED BLADE

	Model: SP1338 For further Information please see page 104
--	---

ACCESSORIES

	Lanyard: CL-36 For further Information please see page 109
	Adapter: DFCCON For further Information please see page 109

SMART RETRACT METAL SQUEEZE GRIP SAFETY KNIFE

FINGER FRIENDLY BLADE



The SLICE Smart-Retracting Metal-Handle Squeeze Knife combines safety and intelligence to reduce injuries without reducing productivity. Particularly safe due to its fully automatic blade retraction, the blade retracts when it loses contact with its cutting material, even if it is still engaged. A blade lock prevents accidental blade exposure during storage. The tool has a durable metal handle that provides comfort, strength and control. It's suitable for left- and right-handed workers, and the tool-free blade-change mechanism and integrated lanyard hole provide extra convenience for your workforce.

ATTRIBUTES

Safety	Maximum Safety
Cutting Depth	21 mm

Cutting Materials

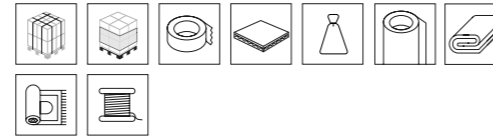

Other Features

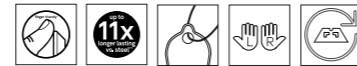

ceramic
finger
friendly®

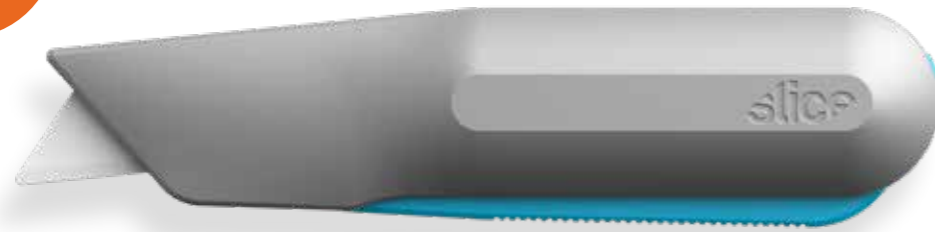

PRODUCT DETAILS

Model	10494
PRODUCT CODES	10494
Dimensions LxWxH	169 x 55 x 27 mm
Weight	140 g
Available in	1 Unit in a Box 1 Inner Carton of 6 1 Master Carton of 24



MOUNTED BLADE



Model: 10524
For further Information
please see page 95

OPTIONAL BLADES



Model: 10523
For further Information
please see page 95



Model: 10525
For further Information
please see page 95

ACCESSORIES



SLICE Holster
For further Information
please see page 109



Lanyard: CL-36
For further Information
please see page 109

SMART RETRACT SQUEEZE GRIP SAFETY KNIFE

FINGER FRIENDLY BLADE



The SLICE Smart-Retracting Squeeze-Grip safety knife is a highly effective, low-risk tool with multiple intelligent safety features. Particularly safe due to its fully automatic blade retraction, the blade retracts when it loses contact with its cutting material, even if it is still engaged. A blade lock prevents accidental blade exposure during storage. The tool has a durable reinforced nylon handle that provides strength and comfort, making it ideal for industrial usage. This clever tool is suitable for left- and right-handed users, and an integrated lanyard hole and tool-free blade-change mechanism help users operate more efficiently.

ATTRIBUTES

Safety	Maximum Safety
Cutting Depth	18 mm

Cutting Materials

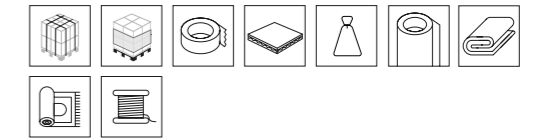

Other Features

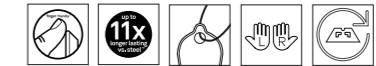

ceramic
finger
friendly®



PRODUCT DETAILS

Model	10564
PRODUCT CODES	10564
Dimensions LxWxH	167 x 63 x 19.5 mm
Weight	78 g
Available in	1 Unit in Retail Packaging 1 Inner Carton of 6 1 Master Carton of 24



MOUNTED BLADE



Model: 10526
For further Information
please see page 95

OPTIONAL BLADES



Model: 10528
For further Information
please see page 95

ACCESSORIES



SLICE Holster
For further Information
please see page 109



Lanyard: CL-36
For further Information
please see page 109

VICTA SMART-RETRACT

FULLY AUTOMATIC WITH BLADE LOCK



The Victa Smart-Retract squeeze grip is a robust safety knife with a metal body, for the toughest tasks! It has a fully automatic blade retraction and so is particularly safe. The blade pulls fully, then returns to the knife body once contact is lost, even if the grip is still engaged. The sturdy metal handle has non-slip rubber components. Easy, no tool blade change is also a feature of the Victa, simply squeeze the grip and depress the blade change button. By means of an eyelet at the end of the handle, the knife can be attached or hung. There is also a blade lock feature for additional safety. Victa is particularly suitable for thicker cutting materials, corrugated board, strapping, adhesive tape, foil, textiles, felt, PVC, leather, rubber, string, etc

ATTRIBUTES

Safety Very High Safety

Cutting Depth 20 mm

Cutting Materials

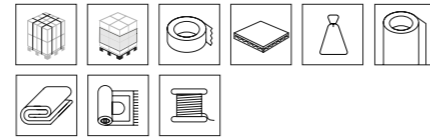

Other Features



PRODUCT DETAILS

Model	VICTA SMART-RETRACT
PRODUCT CODES	E13302-9
Dimensions LxWxH	170 x 60 x 20 mm
Weight	129 g
Available in	1 Unit in a Box 1 Inner Carton of 10 1 Master Carton of 60

MOUNTED BLADE

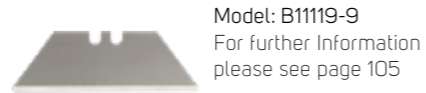

Model: B11119-9
For further information please see page 105

ACCESSORIES



Belt Holster: UKH-671
For further information please see page 110



Lanyard: CL-36
For further information please see page 109



Blade Banks: BH00205 & BH00206
For further information please see page 112



REBEL SMART-RETRACT

FULLY AUTOMATIC WITH BLADE LOCK



The Rebel Smart-Retract squeeze grip safety knife with fully automatic blade retraction. To cut, simply squeeze to expose the blade, due to its fully automatic safety mechanism, the Rebel's blade will retract, even if still engaged, once you lose the tension of your cut. Ambidextrous, so suitable for right- and left-handers. This safety knife is particularly light weight, therefore especially user friendly during repeated use. The easy, no tool blade change is actioned by squeezing to engage the blade and depressing the blade change button. With practical eyelet for lanyard fastening or hanging and a blade lock feature for added safety.

ATTRIBUTES

Safety Very High Safety

Cutting Depth 17 mm

Cutting Materials

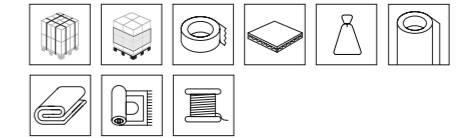

Other Features

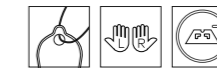

PRODUCT DETAILS

Model	REBEL SMART-RETRACT
PRODUCT CODES	E12304-4
Dimensions LxWxH	143 x 54 x 14 mm
Weight	60 g
Available in	1 Unit in a Box 1 Inner Bag of 10 1 Master Carton of 60

MOUNTED BLADE



Model: B11117-9
For further information please see page 105

OPTIONAL BLADES

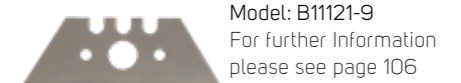

Model: B11121-9
For further information please see page 106

ACCESSORIES

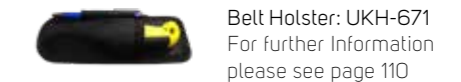

Belt Holster: UKH-671
For further information please see page 110



Lanyard: CL-36
For further information please see page 109



Blade Banks: BH00205 & BH00206
For further information please see page 112



QBAR

FULLY AUTOMATIC / EASY TO CLEAN



The QBAR is a particularly robust safety knife made of aluminium, for the toughest applications! It has a fully automatic blade retraction and so is particularly safe. In addition, a blade with a rounded tip to reduce the risk of punctures is standard. The blade pulls fully automatically, then returns to the grip body, even if your thumb remains on the slider after the cut. The 3-way slider is particularly ergonomic and suitable for horizontal and vertical cuts. Of course, the QBAR is suitable for right- and left-handed users. The sturdy metal handle has good grip, with non-slip rubber components. Your knife is dirty? No problem! Thanks to the central lock it can be opened very easily without tools, to clean and to change the blade. The handle, very practically, accommodates replacement blades. By means of an eyelet at the end of the handle, the QBAR can be attached or hung. The tape splitter on the underside of the knife head protects your blade life. Particularly suitable for thicker cutting materials, corrugated board, strapping, adhesive tape, foil, textiles, felt, PVC, leather, rubber, string, etc.

ATTRIBUTES

Safety	Very High Safety
Cutting Depth	20 mm

Cutting Materials

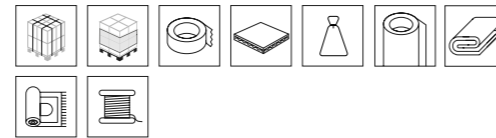

Other Features



PRODUCT DETAILS

Model	QBAR
PRODUCT CODES	QBAR
Dimensions LxWxH	150 x 45 x 22 mm
Weight	184 g
Available in	1 Unit in a Box 1 Inner Carton of 10 1 Master Carton of 60

MOUNTED BLADE



Model: QBD-379 / SPS-92
For further information please see page 107 & 108

OPTIONAL BLADES



Model: QBD-324 / SB-92
For further information please see page 107 & 108

ACCESSORIES



Belt Holster: UKH-675
For further information please see page 111



Lanyard: CL-36
For further information please see page 109



Blade Banks: BH00205 & BH00206
For further information please see page 112



RSC-432

AUTOMATIC GUARD / NSF CERTIFIED



The RSC-432 is a safety knife with a fully automatic protective cap. For cutting, the protective cap is unlocked by means of a slider, after the cut the protective cap covers the blade fully automatically. Therefore, the RSC432 is particularly safe. The three-sided slider makes the knife particularly flexible. Of course, it is suitable for right- and left-handers. The safety knife has an NSF certification (National Sanitation Foundation, USA) and is therefore especially suitable for use in the food industry. The blade is rust-free and cannot be changed. This eliminates the risk of loose blades in production. With integrated tape splitter and practical eyelet for lanyard fastening or hanging.

ATTRIBUTES

Safety	Very High Safety
Cutting Depth	12 mm

Cutting Materials

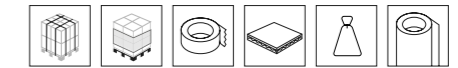

Other Features

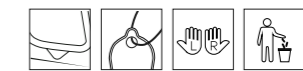

PRODUCT DETAILS

Model	RSC-432
PRODUCT CODES	RSC-432
Dimensions LxWxH	142 x 32 x 24 mm
Weight	20 g
Available in	1 Unit in a Bag 1 Inner Bag of 6 1 Inner Carton of 120 1 Master Carton of 360

ACCESSORIES



Belt Holster: UKH-443
For further information please see page 111



Lanyard: CL-36
For further information please see page 109

AUTO-RETRACTABLE METAL HANDLE SQUEEZE GRIP SAFETY KNIFE

FINGER FRIENDLY BLADE



The SLICE Auto-Retractable Metal-Handle Squeeze Grip Safety Knife is safe, durable and suitable for both left and right hand users. The tool has automatic blade retraction and will only expose the blade if the handle is squeezed. A blade lock prevents accidental blade exposure. This industrial-strength safety knife has a durable metal handle that's comfortable to grip for controlled cuts. Choice of three finger friendly blades.

ATTRIBUTES

Safety	Maximum Safety
Cutting Depth	20 mm
Cutting Materials	
Other Features	

ceramic
finger
friendly®



PRODUCT DETAILS

Model	10493
PRODUCT CODES	10493
Dimensions LxWxH	169 x 55 x 27 mm
Weight	140 g
Available in	1 Unit in Retail Packaging 1 Inner Carton of 6 1 Master Carton of 24



MOUNTED BLADE

	Model: 10524 For further Information please see page 94
--	--

OPTIONAL BLADES

	Model: 10523 For further Information please see page 94
	Model: 10525 For further Information please see page 94

ACCESSORIES

	SLICE Holster For further Information please see page 109
	Lanyard: CL-36 For further Information please see page 109

AUTO-RETRACTABLE SQUEEZE GRIP UTILITY KNIFE

FINGER FRIENDLY BLADE



The SLICE Auto-Retractable Squeeze Grip Utility Knife is the perfect partner. To expose the blade, simply squeeze the handle, and you're ready to work. This handle style works well with gloves, and the locking feature prevents blade exposure when the tool isn't in use. Changing the blade is simple as no extra tools are required. Suitable for left and right hand users. A real favourite.

ATTRIBUTES

Safety	Maximum Safety
Cutting Depth	25 mm
Cutting Materials	
Other Features	

ceramic
finger
friendly®

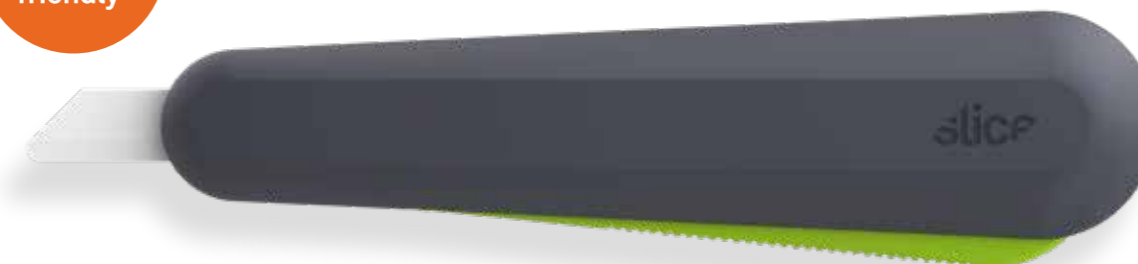

PRODUCT DETAILS

Model	10563
PRODUCT CODES	10563
Dimensions LxWxH	168 x 60 x 18 mm
Weight	77g
Available in	1 Unit in Retail Packaging 1 Inner Carton of 6 1 Master Carton of 24



MOUNTED BLADE

	Model: 10526 For further Information please see page 95
--	--

OPTIONAL BLADES

	Model: 10528 For further Information please see page 95
--	--

ACCESSORIES

	SLICE Holster For further Information please see page 109
	Lanyard: CL-36 For further Information please see page 109

AUTO-RETRACTABLE METAL-HANDLE UTILITY KNIFE

FINGER FRIENDLY BLADE



The SLICE Auto-Retractable Metal-Handle Utility Knife is both safe and powerful: the perfect tool to minimize injuries without impacting your workforce's effectiveness. Automatic blade retraction and easy blade change, plus left and right hand use. Comes with finger friendly rounded tip blade.

ATTRIBUTES

Safety	Maximum Safety
Cutting Depth	24 mm
Cutting Materials	
Other Features	

ceramic
finger
friendly®



PRODUCT DETAILS

Model	10491
PRODUCT CODES	10491
Dimensions LxWxH	170 x 38 x 271 mm
Weight	107 g
Available in	1 Unit in Retail Packaging 1 Inner Carton of 6 1 Master Carton of 48



MOUNTED BLADE

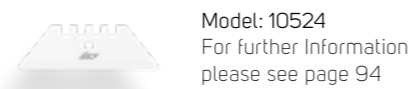

Model: 10524
For further Information
please see page 94

OPTIONAL BLADES

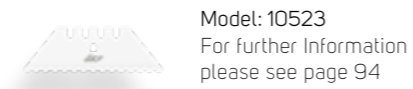

Model: 10523
For further Information
please see page 94

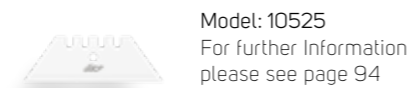

Model: 10525
For further Information
please see page 94

ACCESSORIES



SLICE Holster
For further Information
please see page 109



Lanyard: CL-36
For further Information
please see page 109

AUTO-RETRACTABLE UTILITY KNIFE

FINGER FRIENDLY BLADE



The SLICE Auto-Retractable Utility Knife is the perfect tool for your industrial needs, with a finger-friendly edge that cuts everything but you. The spring-loaded blade automatically retracts when you release the slider on the handle, lowering the risk of accidental blade exposure. A longer blade for thicker cuts, with no tool blade change, add an extra level of safety and convenience for both left and right hand users. Comes with finger friendly rounded tip blade.

ATTRIBUTES

Safety	Maximum Safety
Cutting Depth	20 mm
Cutting Materials	
Other Features	

ceramic
finger
friendly®



PRODUCT DETAILS

Model	10554
PRODUCT CODES	10554
Dimensions LxWxH	153.83 x 35.64 x 211.8 mm
Weight	73 g
Available in	1 Unit in Retail Packaging 1 Inner Carton of 6 1 Master Carton of 24



MOUNTED BLADE

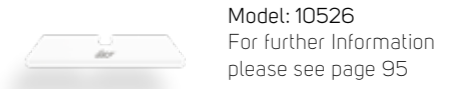

Model: 10526
For further Information
please see page 95

OPTIONAL BLADES

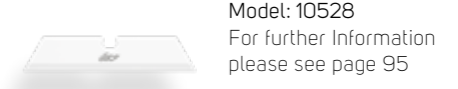

Model: 10528
For further Information
please see page 95

ACCESSORIES



SLICE Holster
For further Information
please see page 109

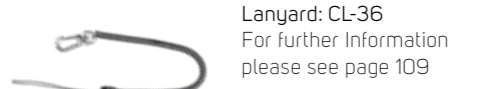

Lanyard: CL-36
For further Information
please see page 109

AUTO-RETRACTABLE INDUSTRIAL SAFETY KNIFE

EXTRA LONG FINGER FRIENDLY BLADE



The SLICE Auto-Retractable Industrial Knife is a long-lasting, heavy-duty tool. Automatic blade retraction adds another level of protection, as the blade can never be accidentally left out. The deep-cutting extra-long blade, which extends up to 79 mm, and durable reinforced nylon handle make it ideal for industrial use. This hardwearing knife is suitable for left- and right-handed workers. Features also include integrated lanyard hole and quick-release, no-tool blade change

ATTRIBUTES

Safety	Maximum Safety
Cutting Depth	79 mm
Cutting Materials	
Other Features	

ceramic
finger
friendly®



PRODUCT DETAILS

Model	10560
PRODUCT CODES	10560
Dimensions LxWxH	155 x 34.3 x 21.5 mm
Weight	86 g
Available in	1 Unit in Retail Packaging 1 Inner Carton of 6 1 Master Carton of 48

MOUNTED BLADE

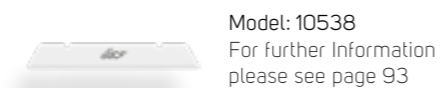

OPTIONAL BLADES

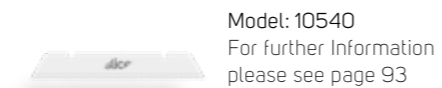
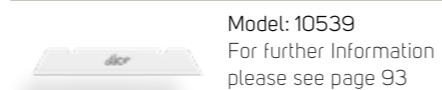

ACCESSORIES

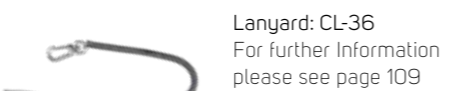
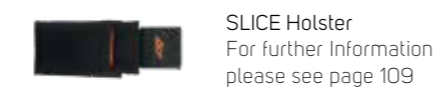

AUTO-RETRACTABLE BOX CUTTER

FINGER FRIENDLY BLADE



The SLICE Auto-Retractable Box Cutter combines safety and ergonomics to reduce injuries and increase efficiency. For additional safeguarding, a textured auto-retractable slider ensures the blade can never be accidentally left out. The cutter has a curved handle that comfortably wraps around your workers' hands, and this award-winning design reduces wrist strain and keeps fingers shielded from debris such as staples. Furthermore, the reinforced nylon handle provides outstanding durability, so this is a great tool for industrial usage. It's suitable for left- and right-handed workers, and the blade is easily changed without any tools - helping your workforce operate efficiently.

ATTRIBUTES

Safety	Maximum Safety
Cutting Depth	20 mm
Cutting Materials	
Other Features	

ceramic
finger
friendly®



PRODUCT DETAILS

Model	10503
PRODUCT CODES	10503
Dimensions LxWxH	177 x 85 x 18.2 mm
Weight	97 g
Available in	1 Unit in Retail Packaging 1 Inner Carton of 6 1 Master Carton of 24

MOUNTED BLADE

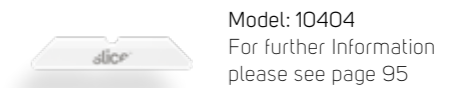

OPTIONAL BLADES

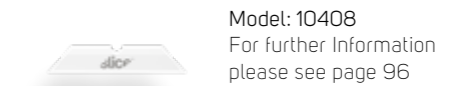

ACCESSORIES

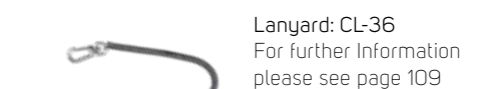
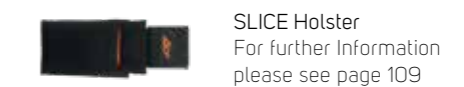

AUTO-RETRACTABLE MINI CUTTER

FINGER FRIENDLY BLADE



This tool is one of our most popular and versatile because it's small but mighty. It's useful for many industrial tasks such as opening and breaking down boxes to cutting through tape, plastic wrap or clamshell packaging, and paper. Suitable for left and right hand users. Attach it to your keys and keep this safety knife close at hand.

ATTRIBUTES

Safety	Maximum Safety
Cutting Depth	9 mm

Cutting Materials

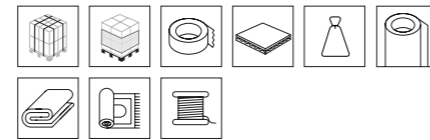

Other Features



ceramic
finger
friendly®



PRODUCT DETAILS

Model	10514
PRODUCT CODES	10514
Dimensions LxWxH	62 x 36.7 x 11.8 mm
Weight	11 g
Available in	1 Unit in Retail Packaging 1 Inner Carton of 12 1 Master Carton of 192



MOUNTED BLADE



Model: 10404
For further Information
please see page 95

OPTIONAL BLADES



Model: 10408
For further Information
please see page 96

ACCESSORIES



Lanyard: CL-36
For further Information
please see page 109

AUTO-RETRACTABLE PEN CUTTER

FINGER FRIENDLY BLADE



The SLICE Auto-Retractable Pen Cutter allows you to work safely with a versatile tool that fits perfectly in your workforce's fingers. The textured auto-retractable slider ensures the blade can never be accidentally left out. The reinforced nylon handle is highly durable, making it a great tool for industrial use. While the familiar, sleek shape of a pen means it is comfortable to hold, has universal uses, and is easy to store. Suitable for both left and right hand users.

ATTRIBUTES

Safety	Maximum Safety
Cutting Depth	12 mm

Cutting Materials

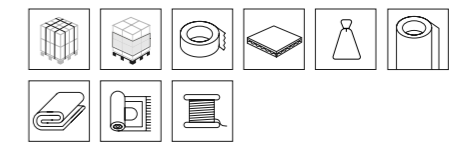

Other Features



ceramic
finger
friendly®



PRODUCT DETAILS

Model	10512
PRODUCT CODES	10512
Dimensions LxWxH	133.5 x 17.3 x 17.3 mm
Weight	27 g
Available in	1 Unit in Retail Packaging 1 Inner Carton of 12 1 Master Carton of 192



MOUNTED BLADE



Model: 10404
For further Information
please see page 95

OPTIONAL BLADES



Model: 10408
For further Information
please see page 96

ACCESSORIES



SLICE Holster
For further Information
please see page 109



Lanyard: CL-36
For further Information
please see page 109

VICTA AUTO-RETRACT

BLADE DEPTH SETTINGS & LOCK

The Victa Auto-Retract is a safety knife with automatic blade retraction. To cut, squeeze the trigger to expose the blade. Suitable for right- and left-handed users. The safety knife is of metal construction, therefore very hard wearing. The easy, no tool blade change is actioned by squeezing the trigger and depressing the blade change button. Three cutting depths can be selected by adjusting the depth button, 4mm, 12mm, 22mm. With practical eyelet for lanyard fastening or hanging and a blade lock feature for added safety.



ATTRIBUTES

Safety	High Safety
Cutting Depth	4, 12, 22 mm

Cutting Materials

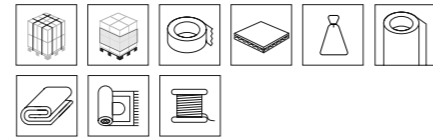

Other Features



PRODUCT DETAILS

Model	VICTA AUTO-RETRACT
PRODUCT CODES	E13206-9
Dimensions LxWxH	170 x 60 x 20 mm
Weight	132 g
Available in	1 Unit in Retail Packaging 1 Inner Carton of 10 1 Master Carton of 60

MOUNTED BLADE

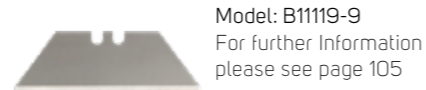

Model: B11119-9
For further information please see page 105

ACCESSORIES

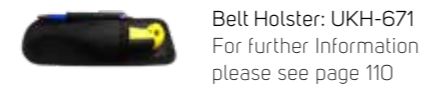

Belt Holster: UKH-671
For further information please see page 110

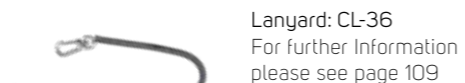

Lanyard: CL-36
For further information please see page 109

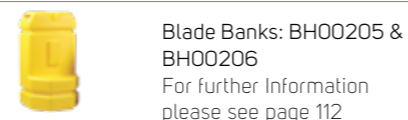

Blade Banks: BH00205 & BH00206
For further information please see page 112



REBEL AUTO-RETRACT

LOCKABLE BLADE FEATURE

The Rebel Auto-Retract is a safety knife with automatic blade retraction. To cut, simply squeeze the trigger to expose the blade. Suitable for right- and left-handed users. This safety knife is particularly light weight, therefore especially user friendly during repeated use. The easy, no tool blade change is actioned by squeezing the trigger and depressing the blade change button. With practical eyelet for lanyard fastening or hanging and a blade lock feature for added safety.



ATTRIBUTES

Safety	High Safety
Cutting Depth	17 mm

Cutting Materials

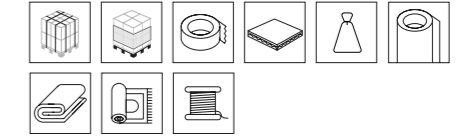

Other Features



PRODUCT DETAILS

Model	REBEL AUTO-RETRACT
PRODUCT CODES	E12209-4
Dimensions LxWxH	143 x 54 x 14 mm
Weight	58 g
Available in	1 Unit in Retail Packaging 1 Inner Carton of 10 1 Master Carton of 60

MOUNTED BLADE

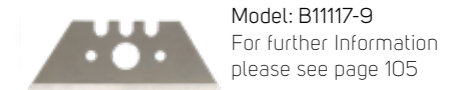

Model: B11117-9
For further information please see page 105

OPTIONAL BLADES



Model: B11121-9
For further information please see page 106

ACCESSORIES

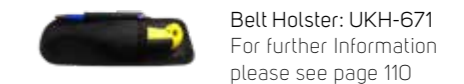

Belt Holster: UKH-671
For further information please see page 110

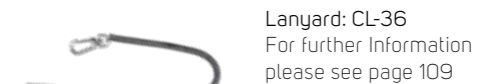

Lanyard: CL-36
For further information please see page 109

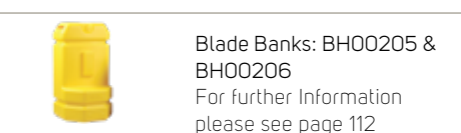

Blade Banks: BH00205 & BH00206
For further information please see page 112



METTI AUTO-RETRACT

BLADE DEPTH SETTINGS & LOCK



The Metti Auto-Retract is a slim safety knife with automatic blade retraction. Suitable for right- and left-handed users with two fixed cutting depths. 5mm and 19mm. This safety knife is light weight, yet robust, due to its metal body. The easy, no tool blade change is actioned by removing the cartridge, opening the hinged component, and locating the new blade onto the magnet. With practical eyelet for lanyard fastening or hanging and a blade lock feature for added safety.

ATTRIBUTES

Safety	High Safety
Cutting Depth	5, 19 mm

Cutting Materials

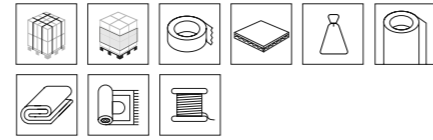

Other Features



PRODUCT DETAILS

Model	METTI
PRODUCT CODES	E13205-9
Dimensions LxWxH	146 x 30 x 16 mm
Weight	60 g
Available in	1 Unit in Retail Packaging 1 Inner Carton of 10 1 Master Carton of 100

MOUNTED BLADE

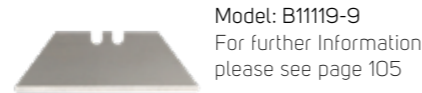

OPTIONAL BLADES

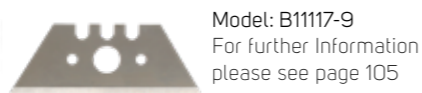

ACCESSORIES

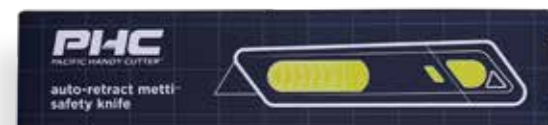
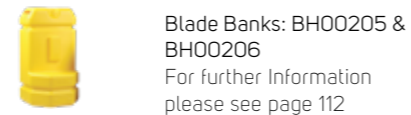
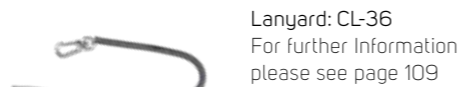

VOLO AUTO-RETRACT

EASY BLADE CHANGE



The Volo Auto-Retract, our budget friendly safety knife. With a blade cutting depth of 13mm, and automatic blade retraction. Suitable for left-hand and right-hand users. Easy, no tool blade change by depressing the slider at the bottom end, when fully exposing the blade. With convenient, practical eyelet for lanyard fastening or hanging.

ATTRIBUTES

Safety	High Safety
Cutting Depth	13 mm

Cutting Materials

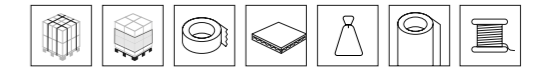

Other Features



PRODUCT DETAILS

Model	VOLO AUTO-RETRACT
PRODUCT CODES	E12204-4
Dimensions LxWxH	130 x 25 x 14 mm
Weight	29 g
Available in	1 Unit in Retail Packaging 1 Inner Carton of 10 1 Master Carton of 100

MOUNTED BLADE



OPTIONAL BLADES

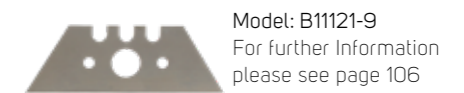

ACCESSORIES

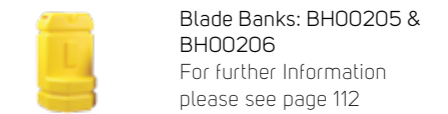

VOLO AUTO-RETRACT DISPOSABLE

ECONOMIC SAFE CUTTING

Volo Auto-Retract Disposable safety knife, another of our budget friendly safety tools. With a blade depth of 14mm, and automatic blade retraction. Suitable for left-hand and right-hand users via the high visibility slider. Fully disposable, mitigating the risk of blade change. With convenient, practical eyelet for lanyard fastening or hanging.



ATTRIBUTES

Safety	High Safety
Cutting Depth	14 mm

Cutting Materials

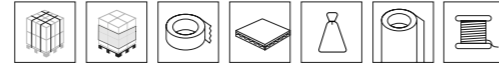

Other Features

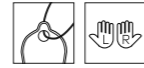

PRODUCT DETAILS

Model	VOLO AUTO-RETRACT DISPOSABLE
PRODUCT CODES	E12206-4
Dimensions LxWxH	130 x 25 x 10mm
Weight	29 g
Available in	1 Inner Carton of 10 1 Master Carton of 100

ACCESSORIES



Lanyard: CL-36
For further information please see page 109

QBS-20

HEAVY DUTY AUTOMATIC



ATTRIBUTES

Safety	High Safety
Cutting Depth	8, 16 mm

Cutting Materials

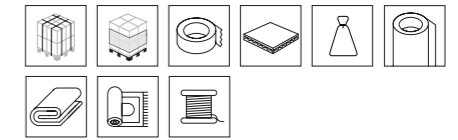

Other Features



The QBS-20 is a large, robust safety knife with automatic blade retraction. It provides you with a high level of safety when cutting. The handle is ergonomically shaped, has a soft rubber grip and a slider built into the top. The blade automatically retracts when cut tension is released. The blade change is tool-free and is very simple. The blades can be turned and used both sides. If your QBS-20 is dirty, you can open and clean it very easily. In addition, spare blades can be stowed in the handle. QBS-20, the ambidextrous, self retracting utility knife in bright orange.



PRODUCT DETAILS

Model	QBS-20
PRODUCT CODES	QBS-20
Dimensions LxWxH	168 x 32 x 27 mm
Weight	197 g
Available in	1 Inner Carton of 10 1 Master Carton of 60

MOUNTED BLADE



Model: QBD-379 / SPS-92
For further information please see page 107 & 108

OPTIONAL BLADES



Model: QBD-324 / SB-92
For further information please see page 107 & 108

ACCESSORIES



Belt Holster: UKH-671
For further information please see page 110



Lanyard: CL-36
For further information please see page 109



Blade Banks: BH00205 & BH00206
For further information please see page 112

RZ3

AMBIDEXTROUS HEAVY DUTY



The RZ3 is a handy, robust metal safety knife with automatic blade retraction. As a result, it provides you with a high level of safety when cutting. The handle is ergonomically shaped and has a three-way slider. The blade automatically retracts when cut tension is released. The blade change is tool-free and is very simple. The blades can be turned and used twice. Therefore, the operation of the RZ3 is very economical. If your RZ3 is dirty, you can open and clean it very easily. In addition, spare blades can be stowed in the handle. For right- and left-handers. And the hi-vis orange makes your knife even safer!

ATTRIBUTES

Safety High Safety

Cutting Depth 11 mm

Cutting Materials

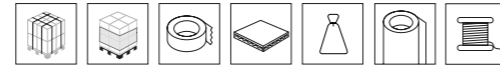

Other Features



PRODUCT DETAILS

Model	RZ3
PRODUCT CODES	RZ3
Dimensions LxWxH	144 x 35 x 25 mm
Weight	136 g
Available in	1 Inner Bag of 10 1 Master Carton of 100

MOUNTED BLADE



Model: SPD-017 / SP-017
For further information please see page 107 & 108

ACCESSORIES



Belt Holster: UKH-430
For further information please see page 111



Lanyard: CL-36
For further information please see page 109



Blade Banks: BH00205 & BH00206
For further information please see page 112

EZ3

AMBIDEXTROUS LIGHT WEIGHT



The EZ3 is a lightweight safety knife with automatic blade retraction. Thus, it offers a high level of safety. Due to the plastic body, it is particularly economical. Changing the blade is very easy, and the knife handle can be opened completely for cleaning. Additional blades can be stowed away in the knife handle. Short blade length, therefore suitable for light cutting activities. Knife in clearly visible yellow.

ATTRIBUTES

Safety High Safety

Cutting Depth 10 mm

Cutting Materials

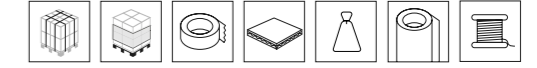

Other Features



PRODUCT DETAILS

Model	EZ3
PRODUCT CODES	EZ3
Dimensions LxWxH	144 x 35 x 25 mm
Weight	28 g
Available in	1 Inner Bag of 25 1 Master Carton of 300

MOUNTED BLADE



Model: SPD-017 / SP-017
For further information please see page 107 & 108

ACCESSORIES



Belt Holster: UKH-430
For further information please see page 111



Lanyard: CL-36
For further information please see page 109



Blade Banks: BH00205 & BH00206
For further information please see page 112

S4SL

AUTOMATIC, THUMB GUARD



The S4SL is a safety knife with automatic blade retraction and additional protective guard. Therefore, it is very safe. The protective guard also serves as a guide, e.g. when topping cartons. With robust integrated tape splitter and spare blade storage. Tool-free blade change. With practical eyelet for lanyard fastening or hanging. The red model is suitable for left-handed users.

ATTRIBUTES

Safety	High Safety
Cutting Depth	13, 18, 20 mm

Cutting Materials

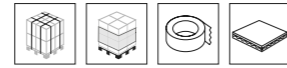

Other Features

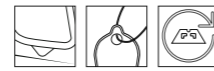

PRODUCT DETAILS

Model	S4SL
PRODUCT CODES	S4SL
Dimensions LxWxH	155 x 32 x 18 mm
Weight	60 g
Available in	1 Inner Bag of 12 1 Master Carton of 72

MOUNTED BLADE



Model: SPD-017 / SP-017
For further information please see page 107 & 108

ACCESSORIES



Belt Holster: UKH-423
For further information please see page 110



Lanyard: CL-36
For further information please see page 109



Blade Banks: BH00205 & BH00206
For further information please see page 112

S4SR

AUTOMATIC, THUMB GUARD



The S4SR is a safety knife with automatic blade retraction and additional protective guard. Therefore, it is very safe. The protective guard also serves as a guide, e.g. when topping cartons. With robust integrated tape splitter and spare blade storage. Tool-free blade change. With practical eyelet for lanyard fastening or hanging. The green model is suitable for right-handed users.

ATTRIBUTES

Safety	High Safety
Cutting Depth	13, 18, 20 mm

Cutting Materials

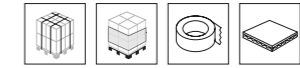

Other Features

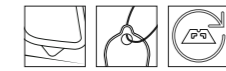

PRODUCT DETAILS

Model	S4SR
PRODUCT CODES	S4SR
Dimensions LxWxH	155 x 32 x 18 mm
Weight	60 g
Available in	1 Inner Bag of 12 1 Master Carton of 72

MOUNTED BLADE



Model: SPD-017 / SP-017
For further information please see page 107 & 108

ACCESSORIES



Belt Holster: UKH-423
For further information please see page 110



Lanyard: CL-36
For further information please see page 109



Blade Banks: BH00205 & BH00206
For further information please see page 112

S7

MULTITOOL



If there is such a thing as an all-rounder, it is without doubt the S7! The knife has an automatic blade retraction offering you a high level of safety. In addition, the blade depth can be adjusted in three lengths. This gives you additional protection and protects your goods. At the same time, the blade can also be activated behind the guard. As a result, the open blade is shielded from immediate access. The angled guard also serves as a cutting guide for box topping. The trapezoidal blade can be turned and used twice, making the S7 particularly economical. At the end of the handle there is an additional concealed blade cutting head, safely activated by the slider, which is ideal for foils and strapping. The slider is locked in place whilst the cutting head is active. Meaning that the blade is locked safely away. A real all-rounder!

ATTRIBUTES

Safety	High Safety
Cutting Depth	2, 8, 13 mm
Blade Access	4 mm
Film Cutter	

Cutting Materials

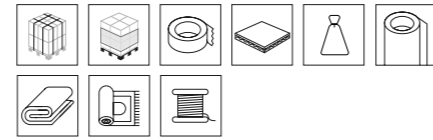

Other Features

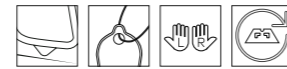

PRODUCT DETAILS

Model	S7
PRODUCT CODES	S7
Dimensions LxWxH	145 x 44 x 20 mm
Weight	68 g
Available in	1 Unit in a Bag 1 Inner Bag of 12 1 Master Carton of 72

MOUNTED BLADE

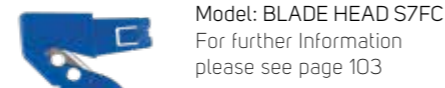
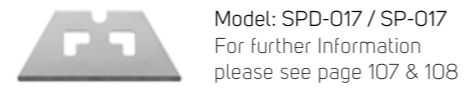

ACCESSORIES

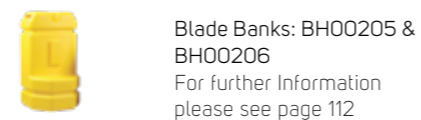
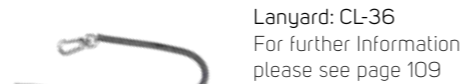

POCKET SAFETY CUTTER

FOLDAWAY AUTOMATIC



ATTRIBUTES

Safety	High Safety
Cutting Depth	11 mm

Cutting Materials

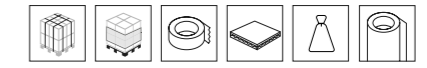

Other Features

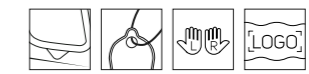

A safety knife for your pocket? Although we generally advise against storing a knife with direct contact with the body, this is quite possible with the Pocket Safety Cutter! The PSC2 is a small but full-fledged, foldable safety knife with automatic blade retraction. As a result, it offers you a high level of safety for light cutting activities. Safety cut, fold, stow away, done! When folded, the knife locks automatically so that it cannot open on its own. It couldn't be safer! With practical metal tape splitter. Fits in any pocket, but also on your key ring or a lanyard. If you want to customize your safety knife, the PSC is particularly suitable thanks to the large flat side surfaces. We are happy to offer you product branding options.



PRODUCT DETAILS

Model	Pocket Safety Cutter PSC2
PRODUCT CODES	PSC2 + COLOUR
Colours	
Dimensions LxWxH	104 x 30 x 9 mm
Weight	26 g
Would you like to print on me?	It's Possible! See page 78
Available in	1 Inner Carton of 12 1 Master Carton of 576

ACCESSORIES



MANUAL UTILITY KNIFE

FINGER FRIENDLY BLADE



The SLICE Manual Utility Knife is designed for a multitude of tasks. It offers four cutting positions so you can choose the correct blade depth for the job at hand and is capable of cutting triple-wall cardboard. The lightweight handle allows for easy storage and transportation and it is suitable for left and right hand use.

ATTRIBUTES

Safety	Maximum Safety
--------	----------------

Cutting Depth	20 mm
---------------	-------

Cutting Materials

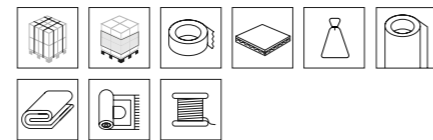

Other Features

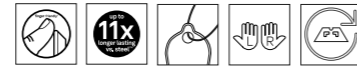

ceramic
finger
friendly®



PRODUCT DETAILS

Model	10550
PRODUCT CODES	10550
Dimensions LxWxH	153.83 x 35.64 x 21.18 mm
Weight	71 g
Available in	1 Unit in Retail Packaging 1 Inner Carton of 6 1 Master Carton of 24



MOUNTED BLADE

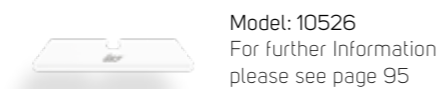

Model: 10526
For further Information
please see page 95

OPTIONAL BLADES



Model: 10528
For further Information
please see page 95

ACCESSORIES



SLICE Holster
For further Information
please see page 109



Lanyard: CL-36
For further Information
please see page 109

MANUAL INDUSTRIAL KNIFE

FINGER FRIENDLY BLADE



The SLICE Manual Industrial Safety Knife was designed to cut through thick materials like foam and fiberglass insulation quickly and efficiently and with far fewer blade changes. We know how much fiberglass can damage blades, so we created the SLICE Manual Industrial Knife. The durable, five-position handle offers four cutting depths for multiple jobs around the production floor and in your home. Switch the blade for left and right hand use.

ATTRIBUTES

Safety	Maximum Safety
--------	----------------

Cutting Depth	76 mm
---------------	-------

Cutting Materials

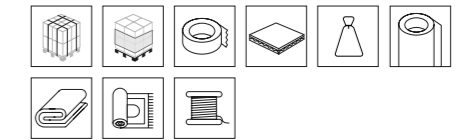

Other Features



ceramic
finger
friendly®



PRODUCT DETAILS

Model	10559
PRODUCT CODES	10559
Dimensions LxWxH	155 x 34.3 x 21.5 mm
Weight	86 g
Available in	1 Unit in Retail Packaging 1 Inner Carton of 6 1 Master Carton of 48



MOUNTED BLADE



Model: 10538
For further Information
please see page 93

OPTIONAL BLADES



Model: 10539
For further Information
please see page 93



Model: 10540
For further Information
please see page 93

ACCESSORIES



SLICE Holster
For further Information
please see page 109



Lanyard: CL-36
For further Information
please see page 109

FOLDING UTILITY KNIFE

FINGER FRIENDLY BLADE



Designed with a sturdy, balanced handle and a convenient finger loop for an optimal grip, the SLICE Folding Knife effectively cuts through various materials, including cardboard, plastic, tape, vinyl, and more. Use the quick release lock to unfold the blade, which boasts two locking positions. Additionally, the SLICE Folding Knife comes equipped with a belt clip for added convenience. From industrial and household uses to DIY projects and working in the warehouse, this tool does it all. Constructed with a sturdy metal body and featuring a finger loop for comfort, this left and right hand tool is a tough customer.

ATTRIBUTES

Safety	Maximum Safety
Cutting Depth	21 mm

Cutting Materials

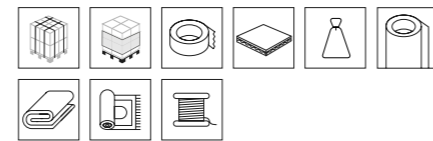

Other Features

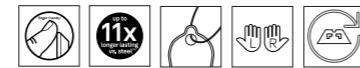

ceramic
finger
friendly®



PRODUCT DETAILS

Model	10562
PRODUCT CODES	10562
Dimensions LxWxH	191.1 x 33.3 x 21.2 mm
Weight	173 g
Available in	1 Unit in Retail Packaging 1 Inner Carton of 6 1 Master Carton of 24 (Inner Carton of 6 is a shelf ready display unit)



MOUNTED BLADE



Model: 10526
For further information please see page 95

OPTIONAL BLADES



Model: 10528
For further information please see page 95



MANUAL PEN CUTTER

FINGER FRIENDLY BLADE



The SLICE Manual Pen Cutter makes everyday and industrial cutting tasks safe and easy. With the familiar, sleek shape of a pen, this versatile tool can solve almost any cutting challenge while keeping you safe. Keep it handy by using its integrated lanyard hole. From its daily use in offices, factory floors, or home garages this style of safety knife is a firm favourite.

ATTRIBUTES

Safety	Maximum Safety
Cutting Depth	20 mm

Cutting Materials

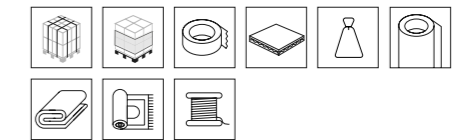

Other Features

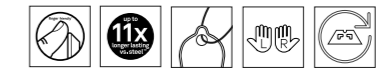

ceramic
finger
friendly®



PRODUCT DETAILS

Model	10513
PRODUCT CODES	10513
Dimensions LxWxH	133.5 x 17.3 x 17.3 mm
Weight	27g
Available in	1 Unit in Retail Packaging 1 Box of 12 1 Box of 192



MOUNTED BLADE



Model: 10404
For further information please see page 95

OPTIONAL BLADES



Model: 10408
For further information please see page 96

ACCESSORIES



Lanyard: CL-36
For further information please see page 109

SAFETY CUTTER

FINGER FRIENDLY BLADE



The SLICE Safety Cutter is a powerful little tool equipped with one of the world's smallest micro-ceramic blade, designed to cut almost anything while keeping you safe. Keep it on your keychain, fridge, or lanyard at work for safe and convenient package opening. It's safe to leave lying around your family, on your desk, or a countertop. From its daily use in industrial settings to opening online orders at your doorstep, SLICE makes people and places safer. Suitable for left and right hand users, featuring a built in magnet and keyring eyelet, there is no reason to not have one close at hand!

ATTRIBUTES

Safety	Maximum Safety
Cutting Depth	2 mm

Cutting Materials

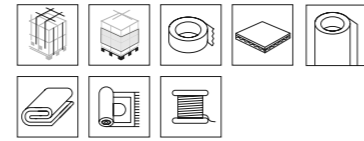

Other Features

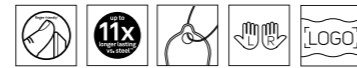

ceramic
finger
friendly®



PRODUCT DETAILS

Model	00100 & 00200
PRODUCT CODES	00100 & 00200
Dimensions LxWxH	61.24 x 30.76 x 5.71 mm
Weight	6 g
Would you like to print on me?	It's Possible! See page 78
Available in	1 Unit in Retail Packaging 1 Inner Carton of 10 retail dispenser 1 Master Carton of 48 1 Master Carton of 288 (Inner Carton of 10 is a shelf ready display unit)



00100 Retail Dispenser



00200



00100

QBA-375

AUTOMATIC BLADE RELOAD



The QBA-375 is an extremely robust utility knife and meets the strongest requirements! Sturdy metal housing, ergonomically shaped, with non-slip soft rubber components. Fresh blades are automatically reloaded from a storage magazine! It couldn't be more practical. Suitable for tough continuous use.

ATTRIBUTES

Safety	Basic Safety
Cutting Depth	8, 18, 27 mm

Cutting Materials

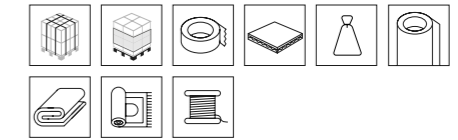

Other Features



PRODUCT DETAILS

Model	QBA-375
PRODUCT CODES	QBA-375
Dimensions LxWxH	165 x 36 x 24 mm
Weight	239 g
Available in	1 Unit in Retail Packaging 1 Inner Carton of 10 1 Master Carton of 60



MOUNTED BLADE



Model: QBD-324 / SPS-92
For further Information
please see page 107 & 108

OPTIONAL BLADES



Model: QBD-379 / SB-92
For further Information
please see page 107 & 108

ACCESSORIES



Belt Holster: UKH-671
For further Information
please see page 110



Lanyard: CL-36
For further Information
please see page 109



Blade Banks: BH00205 & BH00206
For further Information
please see page 112

S5L

PRESET BLADE DEPTHS



The S5L is a big hit in retail and supermarkets! It has three adjustable blade lengths for box topping, for shallow window cuts or for deep cuts. The extremely stable metal blade guard protects the user. At the same time, the angled guard serves as a cutting guide, e.g. when topping boxes. At the end of the handle there is a fold-out, film cutter with concealed blade, which is ideal for foils and strapping. Intergrated robust tape splitter. Spare blades can be comfortably placed under control in the compartment. Tool-free blade change. With practical eyelet for lanyard fastening or hanging. The red model is suitable for left-handed users.

ATTRIBUTES

Safety	Basic Safety
Cutting Depth	5, 14, 19 mm
Blade Access Film Cutter	4 mm

Cutting Materials



Other Features

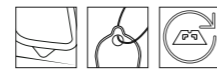

PRODUCT DETAILS

Model	S5L
PRODUCT CODES	S5L
Dimensions LxWxH	157 x 23 x 32 mm
Weight	57 g
Mounted blade	SPD-017, S5FC
Available in	1 Inner Bag of 12 1 Master Carton of 72

MOUNTED BLADE

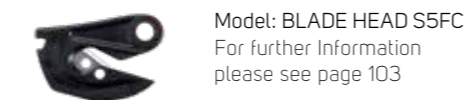
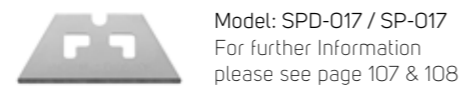

ACCESSORIES

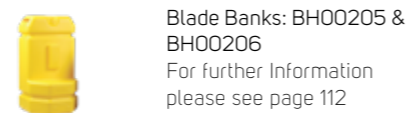

S5R

PRESET BLADE DEPTHS



The S5R is a big hit in retail and supermarkets! It has three adjustable blade lengths for box topping, for shallow window cuts or for deep cuts. The extremely stable metal blade guard protects the user. At the same time, the angled guard serves as a cutting guide, e.g. when topping boxes. At the end of the handle there is a fold-out, film cutter with concealed blade, which is ideal for foils and strapping. Intergrated robust tape splitter. Spare blades can be comfortably placed under control in the compartment. Tool-free blade change. With practical eyelet for lanyard fastening or hanging. The green model is suitable for right-handed users.

ATTRIBUTES

Safety	Basic Safety
Cutting Depth	5, 14, 19 mm
Blade Access Film Cutter	4 mm

Cutting Materials



Other Features

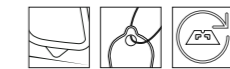

PRODUCT DETAILS

Model	S5R
PRODUCT CODES	S5R
Dimensions LxWxH	157 x 23 x 32 mm
Weight	57 g
Available in	1 Inner Bag of 12 1 Master Carton of 72

MOUNTED BLADE

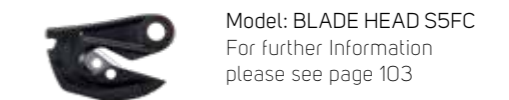
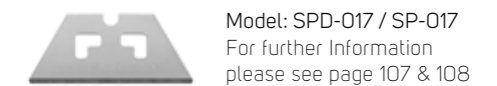

ACCESSORIES

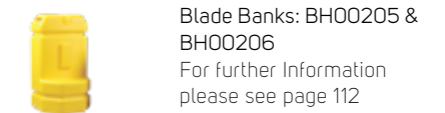

CRAFT KNIFE WITH SAFETY CAP

FINGER FRIENDLY BLADE



The SLICE Craft Knife gives you safety and control: the perfect tool for precision cutting with lower risk of lacerations. It's durable handle with an anti-slip grip allows you complete control over your SLICE Craft Knife, giving you the freedom to create comfortably. The blade is powerful enough to cut your material without cutting you. You'll never lose the safety cap, as it's attached to the knife. Simply expose the blade by twisting the cap to unlock it, then slide it down the handle and rotate again. Left and right hand users will love this precision tool.

ATTRIBUTES

Safety	Maximum Safety
Cutting Depth	15 mm
Cutting Materials	
Other Features	

ceramic
finger
friendly®



PRODUCT DETAILS

Model	10589
PRODUCT CODES	10589
Dimensions LxWxH	164.5 x 12.45 x 12.45 mm
Weight	18.5 g
Available in	1 Unit in Retail Packaging 1 Inner Carton of 12 1 Master Carton of 192



MOUNTED BLADE

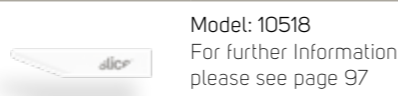

OPTIONAL BLADES

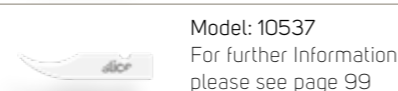
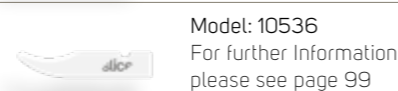
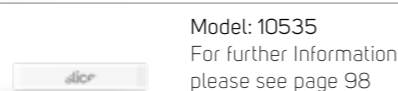
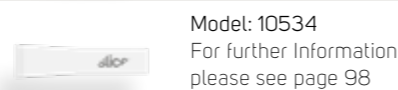
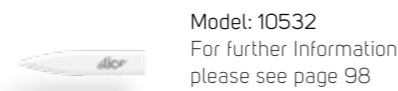
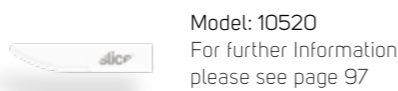
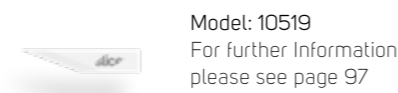

SCALPEL

FINGER FRIENDLY BLADE



With a lightweight handle, you can create delicate lines and details with the SLICE Scalpel. It's ability to precision cut while keeping you safe from injuries will take your art to the next level. The SLICE Scalpel is suitable for left and right hand use and is compatible with multiple blades, so your artistic possibilities are endless. This tool's seamless blade changing lowers the risk of cuts significantly. From cutting stencils to slicing fondant and sculpting ceramics this tool does it all! A safety cap is also included to protect your blade when not in use.

ATTRIBUTES

Safety	Maximum Safety
Cutting Depth	17 mm
Cutting Materials	
Other Features	

ceramic
finger
friendly®



PRODUCT DETAILS

Model	10568
PRODUCT CODES	10568
Dimensions LxWxH	139.5 x 9.8 x 5.16 mm
Weight	4.5 g
Available in	1 Unit in Retail Packaging 1 Inner Carton of 12 1 Master Carton of 192



MOUNTED BLADE

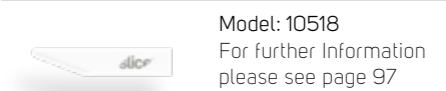

OPTIONAL BLADES

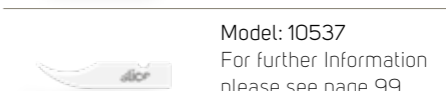
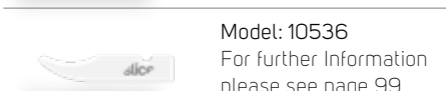
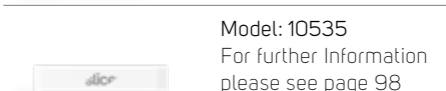
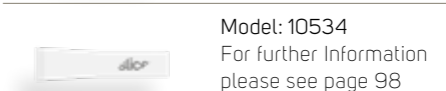
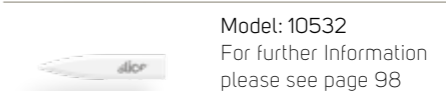
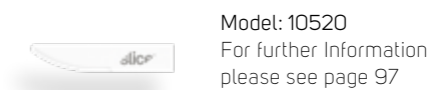
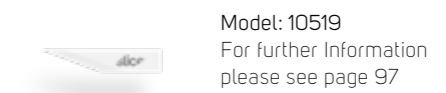

MANUAL PRECISION CUTTER

FINGER FRIENDLY BLADE



Getting frustrated while trying to cut in small spaces and tight corners with a dull scissor? Look no further; the SLICE Precision Cutter is the perfect tool for crafters who want to cut various materials without worrying about harming themselves or their project. A favourite tool of flexible packaging manufacturers for cutting film. From its daily use in offices slicing cardstock, stickers, and paper, to cutting out shapes in mixed media art. It's all in the detail!



PRODUCT DETAILS

Model	10416
PRODUCT CODES	10416
Dimensions LxWxH	141 x 11.2 x 9.1 mm
Weight	7.4 g
Available in	1 Unit in Retail Packaging 1 Inner Carton of 12 1 Master Carton of 192



ATTRIBUTES

Safety	Maximum Safety
Cutting Depth	1 mm
Cutting Materials	
Other Features	

MOUNTED BLADE



Model: 10418
For further information please see page 99

DEBURRING TOOL

FINGER FRIENDLY BLADE



Are you tired of your deburring tool not keeping up with the task at hand? Frustrated because you can't get rid of those burrs? The SLICE Deburring Tool is a powerful, durable tool created specifically for industrial settings. Compatible with SLICE's convex and concave deburring blades, this deburring tool provides convenient blade storage so you can seamlessly switch blade styles while you work. The sturdy nylon handle is lightweight and easy to wield, allowing you to access hard-to-reach areas and awkward angles. From deburring sheet metal edges to 3D-printed prototypes, this left and right hand tool is the answer.

ATTRIBUTES

Safety	Maximum Safety
Cutting Materials	
Other Features	



RETRACTABLE PRECISION CUTTER

FINGER FRIENDLY BLADE



The SLICE Retractable Precision Cutter features a plunger that retracts its finger-friendly blade with a simple click, and the familiar pen shape offers an easy grip. The Retractable Precision Cutter is ideal for precise cuts of thin materials. Designed for safety and effectiveness, this tool boasts a durable handle that gives you effortless control. Additionally, no extra tool is required to change blades, minimising the risk of potential lacerations. Suitable for left and right hand users.



PRODUCT DETAILS

Model	10417
PRODUCT CODES	10417
Dimensions LxWxH	135 x 11.7 x 14.26 mm
Weight	12.5 g
Available in	1 Unit in Retail Packaging 1 Inner Carton of 12 1 Master Carton of 192



ATTRIBUTES

Safety	Maximum Safety
Cutting Depth	1 mm
Cutting Materials	
Other Features	

MOUNTED BLADE



Model: 10418
For further information please see page 99

PRODUCT DETAILS

Model	10482
PRODUCT CODES	10482
Dimensions LxWxH	164.5 x 23.2 x 8.6 mm
Weight	37 g
Available in	1 Unit in Retail Packaging 1 Inner Carton of 12 1 Master Carton of 192



MOUNTED BLADE



Model: 10483
For further information please see page 96

OPTIONAL BLADES



Model: 10484
For further information please see page 96

INVISIBLE AND
YET SO VALUABLE!



KLEEN safety knives are made of plastic with an antimicrobial additive.

This additive drastically restricts the growth of many bacteria and germs on the knife. That's why KLEEN safety knives are certified according to ISO 22196.

The antibacterial active ingredient is integral to the plastic, so it lasts for the lifetime of the knife.

EBC1X KLEEN

INHERENTLY ANTIMICROBIAL



The EBC1 is a particularly robust safety knife with a concealed blade. Here in KLEEN antimicrobial version. Disposable product in hi-vis green with integral tape splitter.



PRODUCT DETAILS

Model	EBC1X KLEEN
PRODUCT CODES	EBC1X
Dimensions LxWxH	159 x 47 x 10 mm
Weight	23 g
Accessories	Belt holster, lanyard, adapter
Available in	1 Bag of 50 1 Box of 300

ATTRIBUTES

Safety	Maximum Safety
Blade Access	6 mm
Cutting Materials	
Other Features	

KLEVER KUTTER KLEEN

INHERENTLY ANTIMICROBIAL

The KLEVER KUTTER is our all-rounder! And the forefather of all safety knives with a concealed blade! Small, handy, versatile, and especially safe! Here in our KLEEN antimicrobial stainless steel blade version.

KLEVER.



PRODUCT DETAILS

Model	KLEVER KUTTER KLEEN KCJ-1XSS
PRODUCT CODES	KCJ-1XSS
Dimensions LxWxH	119 x 33 x 4 mm
Weight	16 g
Would you like to print on me? It's Possible! See Page 78	
Accessories	Belt holster, lanyard
Available in	1 Inner Bag of 10 1 Master Carton of 1000

ATTRIBUTES

Safety	Maximum Safety
Blade Access	3 mm
Cutting Materials	
Other Features	

DFC364X KLEEN

INHERENTLY ANTIMICROBIAL



The DFC364X KLEEN - our film specialist - particularly suitable for puncturing due to the long nose. For foil of any kind, adhesive tape, strapping. The integrated tape splitter minimises blade use.



PRODUCT DETAILS

Model	DFC364X KLEEN
PRODUCT CODES	DFC364X
Dimensions LxWxH	168 x 63 x 10 mm
Weight	22 g
Accessories	Belt holster, lanyard, adapter
Available in	1 Inner Bag of 50 1 Master Carton of 300

ATTRIBUTES

Safety	Maximum Safety
Blade Access	4 mm
Cutting Materials	
Other Features	

KLEVER XCHANGE 20 KLEEN

INHERENTLY ANTIMICROBIAL

The double blade head makes the knife particularly economical. "Keep the handle, replace the head!" Here in our Kleen version, made of antimicrobial plastic, certified according to ISO 22196.



KLEVER.

PRODUCT DETAILS

Model	KLEVER XCHANGE KLEEN KCJ-XC-20X
PRODUCT CODES	KCJ-XC-20X
Dimensions LxWxH	164 x 39 x 10 mm
Weight	34 g
Mounted blade	KCJ-XH-20X
Optional Blades	KCJ-XH-30X, KCJ-XH-35X
Accessories	Belt holster, lanyard
Available in	1 Bag of 12 1 Box of 144

ATTRIBUTES

Safety	Maximum Safety
Blade Access	6 mm
Cutting Materials	
Other Features	

KLEVER XCHANGE 35 KLEEN

INHERENTLY ANTIMICROBIAL

The knife handle is reusable in many ways. With integrated scraper and tape splitter and practical lanyard eyelet. Due to the wider blade access, thicker materials can also be cut. Kleen antimicrobial version with built in scraper.



KLEVER.

PRODUCT DETAILS

Model	KLEVER XCHANGE KLEEN KCJ-XC-35X
PRODUCT CODES	KCJ-XC-35X
Dimensions LxWxH	176 x 49 x 10 mm
Weight	37 g
Mounted blade	KCJ-XH-35X
Optional Blades	KCJ-XH-20X, KCJ-XH-30X
Accessories	Belt holster, lanyard
Available in	1 Bag of 12 1 Box of 144

ATTRIBUTES

Safety	Maximum Safety
Blade Access	8 mm
Cutting Materials	
Other Features	

KLEVER XCHANGE 30 KLEEN

INHERENTLY ANTIMICROBIAL

Kleen antimicrobial, wide head version. Here in striking green. With integrated tape splitter and practical lanyard eyelet. Can also be combined with other any of our XCHANGE blade heads - a real all-rounder!



KLEVER.

PRODUCT DETAILS

Model	KLEVER XCHANGE KLEEN KCJ-XC-30X
PRODUCT CODES	KCJ-XC-30X
Dimensions LxWxH	176 x 49 x 10 mm
Weight	37 g
Mounted blade	KCJ-XH-30X
Optional Blades	KCJ-XH-20X, KCJ-XH-35X
Accessories	Belt holster, lanyard
Available in	1 Inner Bag of 12 1 Master Carton of 144

ATTRIBUTES

Safety	Maximum Safety
Blade Access	8 mm
Cutting Materials	
Other Features	

KLEVER XCHANGE 65 KLEEN

INHERENTLY ANTIMICROBIAL

The knife handle is reusable in many ways. Keep the handle and replace the head! Here with our Kleen XD, SmoothKut head, designed to prevent the blade from getting clogged up and engineered for extra strength. Lasting up to 4x longer and 50% Stronger. Other features include the integrated tape splitters and lanyard eyelet.



KLEVER.

PRODUCT DETAILS

Model	KLEVER XCHANGE KLEEN KCJ-XC-65X
PRODUCT CODES	KCJ-XC-65X
Dimensions LxWxH	178 x 45 x 10 mm
Weight	39 g
Mounted Blade	KCJ-XH-65X
Optional Blades	KCJ-XH-20X, KCJ-XH-30X KCJ-XH-35X
Accessories	Belt holster, lanyard
Available in	1 Inner Bag of 12 1 Master Carton of 144

ATTRIBUTES

Safety	Maximum Safety
Blade Access	5 mm
Cutting Materials	
Other Features	

NSF FOOD ZONE PRODUCTS

What is NSF?

NSF International, The Public Health and Safety Organisation, is a global independent organisation that develops public health standards for products in the food, water and health sciences and consumer goods industries. The NSF Food Equipment Certification Programme sets the standards that establish the minimum food protection and sanitation equipment requirements for food handling and processing equipment. Search for accredited KLEVER Innovations and Pacific Handy Cutter tools here: www.nsf.org



What is the 'Food Zone'?

The NSF food equipment standards define separate "Zones" to classify surfaces or areas of with different levels of exposure to food products.

Food Zones are areas intended to be exposed to indirect food contact. Equipment or materials that are Food Zone Certified may be used near or have indirect contact with food and are also suitable for use in Splash and Nonfood Zones.

Splash Zones are areas that are exposed to routine soiling from splashes and spills, but not intended for contact with consumable food.

Nonfood Zones are areas that are not exposed to food or splashes.

EU HACCP Colour Recommendations

- RED = RAW MEAT / POULTRY
- WHITE = CHEESE / BREAD / BAKING
- GREEN = FRUITS / HERBS / SALADS
- BLUE = SEAFOOD
- BROWN = VEGETABLES
- YELLOW = COOKED MEAT

What are HACCP Guidelines? Why are the colours important? Are the colour designations mandatory?

HACCP (Hazard Analysis Critical Control Point) is a management system in which food safety is addressed through the analysis and control of raw food hazards from production to manufacturing and consumption. HACCP guidelines provide common best practices like a recommended colour-coding system, and while not mandatory, following a colour-coded protocol for designated food areas is highly beneficial for optimal food safety.

KLEVER KUTTER NSF FOOD ZONE

NSF APPROVED

KLEVER.

The KLEVER KUTTER NSF Food Zone with concealed blade. Small, handy, versatile, and especially safe! Highest level of safety, protecting users and goods at the same time. Double blade head, so particularly economical. Disposable. 6 HACCP food group colours. Stainless steel blade and our KLEEN antimicrobial ingredient make this a unique proposition. Ideal for single-wave corrugated, cardboard, foil, adhesive tape, delivery note bags, strapping tape, paper, string, etc. With practical eyelet for lanyard fastening or hanging.

ATTRIBUTES

Safety	Maximum Safety
Blade Access	3.mm

Cutting Materials

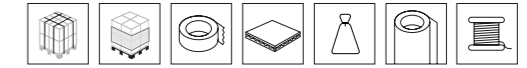

Other Features

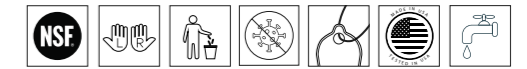

PRODUCT DETAILS

Model	KLEVER KUTTER KCJ-1SS
PRODUCT CODES	KCJ-1SS + COLOUR
Colours	
Dimensions LxWxH	119 x 33 x 4 mm
Weight	16 g
Accessories	Belt holster, lanyard
Available in	1 Inner Bag of 10 1 Master Carton of 200

DFC-364NSF

NSF APPROVED

The DFC364NSF is a safety cutter with a concealed blade offering the highest level of safety. Our film specialist - particularly suitable for puncturing due to the long nose. Designed for foil of any kind, adhesive tape, strapping and banding. The integrated tape splitter minimises the use of the blade. A disposable product, with practical eyelet for fastening a lanyard or hanging. Choice of three food group colours, each with a stainless steel blade. NSF certified.



ATTRIBUTES

Safety	Maximum Safety
Blade Access	4 mm
Cutting Materials	
Other Features	



PRODUCT DETAILS

Model	DFC-364NSF
PRODUCT CODES	DFC-364NSF + COLOUR
Colours	
Dimensions LxWxH	168 x 63 x 10 mm
Weight	22 g
Accessories	Belt holster, lanyard, adapter
Available in	1 Inner Bag of 50 1 Master Carton of 300

BC-347

NSF APPROVED

NSF certified bag cutter, with concealed, stainless-steel blade. Here in a box of 12. Featuring integral tape splitter and lanyard attachment eyelet. This disposable pocket-sized cutter is perfect for cutting food pouches, films, plastic bags and shrink wrap. Also available bulk packed. Ask us for more information.



ATTRIBUTES

Safety	Maximum Safety
Blade Access	3 mm
Cutting Materials	
Other Features	



PRODUCT DETAILS

Model	BC-347 BAG CUTTER
PRODUCT CODES	BC-347
Dimensions LxWxH	75 x 59 x 5 mm
Weight	11.7 g
Accessories	Lanyard
Available in	1 Inner Carton of 12 1 Master Carton of 576



FINDABLE SO ESSENTIAL!

In many industries, foreign particles or objects must be avoided at all costs. These include the food, chemical and pharmaceutical industries, but also many others. Metal parts can usually be reliably detected by detectors. But what about plastic parts? MDP stands for "metal detectable plastic": plastic that is molded with the smallest metal particles and is thus also detected by detectors. We provide you with samples that are available to individually adjust your sensors based on our products.



KLEVER KUTTER MD

STAINLESS STEEL BLADE

The KLEVER KUTTER MD offers the highest level of safety, protecting users and goods at the same time. Double blade head, so particularly economical. Disposable. Stainless steel blade and our KLEEN antimicrobial ingredient make this a unique proposition. Our metal-detectable version, specially designed for the food, pharmaceutical and chemical industries. Ideal for single-wave corrugated, cardboard, foil, adhesive tape, delivery note bags, strapping tape, paper, string, etc. With practical eyelet for lanyard fastening or hanging.

KLEVER.

ATTRIBUTES

Safety Maximum Safety

Blade Access 3 mm

Cutting Materials

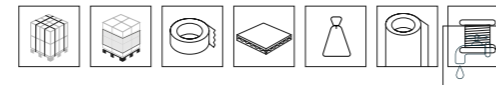

Other Features



PRODUCT DETAILS

Model	KLEVER KUTTER MD KCJ-1SSMDX
PRODUCT CODES	KCJ-1SSMDX
Dimensions LxWxH	119 x 33 x 4 mm
Weight	21g
Available in	1 Inner Bag of 10 1 Master Carton of 200

KLEVER EXCEL PLUS MD

STAINLESS STEEL BLADE

The KLEVER EXCEL PLUS MD is a safety knife with a concealed blade, the highest level of safety. It protects people and material at the same time. Thanks to the metal-detectable plastic, the safety knife is very well suited for use in the food, chemical or pharmaceutical industries. This disposable product cuts up to double-wall corrugated cardboard, film, adhesive tape, strapping tape, etc. With practical eyelet for lanyard fastening or hanging.



KLEVER.

PRODUCT DETAILS

Model	KLEVER EXCEL PLUS MD PLS-400-30MD
PRODUCT CODES	PLS-400-30MD
Dimensions LxWxH	175 x 41 x 8 mm
Weight	27 g
Available in	1 Inner Bag of 10 1 Master Carton of 200

ATTRIBUTES

Safety Maximum Safety

Blade Access 8 mm

Cutting Materials

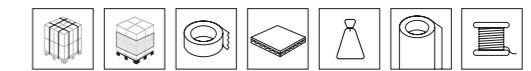

Other Features

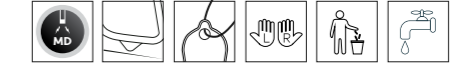

KLEVER KS-101SS-W

100% STAINLESS STEEL

Do you have particularly high demands on hygiene? Do you need a safety knife that is made entirely of stainless steel? Do you want a safe cutting tool that is particularly easy to disassemble because it consists of only two parts (plus blade)? Are you looking for a safety knife that is particularly easy to clean? Then the KLEVER KS101SS-W safety knife is the one for you. It cuts up to 1.5-wall corrugated cardboard, but also almost any other material. Suitable for auto-clave cleaning.



KLEVER.

PRODUCT DETAILS

Model	KLEVER KS-SERIES KS-101SS-W
PRODUCT CODES	KS-101SS-W
Dimensions LxWxH	141 x 28 x 4 mm
Weight	37 g
Mounted blade	HB-8820SS
Available in	1 Inner Bag of 5 1 Master Carton of 25

ATTRIBUTES

Safety Maximum Safety

Blade Access 6 mm

Cutting Materials

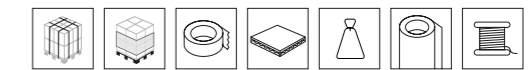

Other Features



DFC364 MD

STAINLESS STEEL BLADE!

The DFC364 MD is a metal detectable safety cutter with a concealed blade. It offers the highest level of safety protecting people and goods at the same time. Ideal for use in areas where metal detectability is important, e.g. the food, chemical or pharmaceutical industries. Our film specialist - particularly suitable for puncturing due to the long nose. Designed for foil of any kind, adhesive tape, banding & strapping. The integrated tape splitter protects the blade. With practical eyelet for lanyard fastening.



PHC
PACIFIC HANDY CUTTER®

PRODUCT DETAILS

Model	DFC364 MD
PRODUCT CODES	DFC364 MD
Dimensions LxWxH	168 x 63 x 10 mm
Weight	26 g
Available in	1 Inner Bag of 50 1 Master Carton of 300

ATTRIBUTES

Safety	Maximum Safety
Blade Access	4 mm
Cutting materials	
Other features	

VOLO AUTO-RETRACT MD

STAINLESS STEEL BLADE

Volo Auto-Retract MD, our budget friendly safety knife, with a blade cutting depth of 13mm, and automatic blade retraction. Here in fully metal detectable version, designed for the food, chemical or pharmaceutical industries. Suitable for left-hand and right-hand users. Easy, no tool blade change by depressing the slider at the bottom end, when fully exposing the blade. With convenient, practical eyelet for lanyard fastening or hanging.



PHC
PACIFIC HANDY CUTTER®

PRODUCT DETAILS

Model	VOLO AUTO-RETRACT MD
PRODUCT CODES	E12205-4
Dimensions LxWxH	130 x 25 x 14 mm
Weight	34 g
Available in	1 Unit in Retail Packaging 1 Inner Carton of 10 1 Master Carton of 100

ATTRIBUTES

Safety	High Safety
Cutting depth	13 mm
Cutting materials	
Other features	

MOUNTED BLADE



Model: B11118-9
Stainless Steel
For further Information
please see page 91

METTI MD

STAINLESS STEEL BLADE

The Metti MD Auto-Retract is a slim safety knife with automatic blade retraction. Here in fully metal detectable version, ideal for the food, chemical or pharmaceutical industries. Suitable for right- and left-handed users with two fixed cutting depths. 5mm and 19mm. This safety knife is light weight, yet robust, due to its metal body. The easy, no tool blade change is actioned by removing the cartridge, opening the hinged component, and locating the new blade. With practical eyelet for lanyard fastening or hanging and a blade lock feature for added safety.



PHC
PACIFIC HANDY CUTTER®

PRODUCT DETAILS

Model	METTI MD
PRODUCT CODES	E12208-9
Dimensions LxWxH	146 x 30 x 16 mm
Weight	64 g
Mounted Blade	B11118-9 (Stainless Steel)
Accessories	Belt holster, lanyard
Available in	1 Unit in Retail Packaging 1 Inner Carton of 10 1 Master Carton of 100

ATTRIBUTES

Safety	High Safety
Cutting Depth	5, 19 mm
Cutting Materials	
Other Features	

VOLO AUTO-RETRACT DISPOSABLE MD

STAINLESS STEEL BLADE

Volo Auto-Retract Disposable MD safety knife, another of our budget friendly safety tools. With a blade cutting depth of 14mm, and automatic blade retraction. Here in fully metal detectable version, ideal for the food, chemical or pharmaceutical industries. Suitable for left-hand and right-hand users. Fully disposable, mitigating the risk of blade change. With convenient, practical eyelet for lanyard fastening or hanging.



PHC
PACIFIC HANDY CUTTER®

PRODUCT DETAILS

Model	VOLO AUTO-RETRACT DISPOSABLE MD
PRODUCT CODES	E12207-4
Dimensions LxWxH	130 x 25 x 10mm
Weight	34 g
Available in	1 Inner Carton of 10 1 Master Carton of 100

ATTRIBUTES

Safety	High Safety
Cutting depth	14 mm
Cutting materials	
Other features	

94%

OF PEOPLE REMEMBER WHERE THEY RECEIVED A PROMOTIONAL GIFT.



BRANDED USEFULNESS!

The importance of promotional products for business promotion can be gauged from these stats. According to a study by PPAI, 94% of people remember where they received a promotional product gift.

The study reveals that 83% of consumers like to get promotional products that has an advertising message. Those who receive the products, 85% of them do business with the advertiser. Furthermore, 58% of the surveyed consumers said they keep the gift items from one year to four years.

Other important stats revealed by the study is that 89% of the consumers said they could recall the advertiser's name or company name for 24 months after getting the items.

Our professional safety knives can be branded for your own use or as a promotional giveaway. So, you can project your corporate image in the hands of the safety knife users every day.

Why not add a QR code? Then prospective customers can find you easily via their smartphones.

With low minimum order quantities and multicolour, high resolution printing available. Enquire today! All we need is a vector file of your logo.

KLEVER KUTTER

ADD YOUR LOGO - LOW MOQ

The KLEVER KUTTER is our all-rounder - so also ideal as a branded knife! Practical, extremely safe, attractively printed - so you leave a perfect and lasting impression! White is great for printing. Bright colours are overall easier to print than dark ones. For printing we just need your logo. Just talk to us.

PRODUCT DETAILS

Model	KLEVER KUTTER KCJ-1
PRODUCT CODES	KCJ-1 + COLOUR
Colours	
Dimensions LxWxH	119 x 33 x 4 mm
Weight	16 g
Would you like to print on me?	Possible from just 200 pieces!

KLEVER.



ATTRIBUTES

Safety	Maximum Safety
Blade Access	3 mm
Cutting Materials	
Other Features	

VPA GS
geprüfte Sicherheit

KLEVER KONCEPT

ADD YOUR LOGO - LOW MOQ

The KLEVER KONCEPT has a double blade head, so particularly economical and is maximum level of safety, protecting users and goods at the same time. Get your branding printed to keep your brand at the forefront of your customers mind! For printing we just need your logo. Just talk to us.

PRODUCT DETAILS

Model	KLEVER KONCEPT KCJ-2
PRODUCT CODES	KCJ-2 + COLOUR
Colours	
Dimensions LxWxH	145 x 36 x 10 mm
Weight	17 g
Would you like to print on me?	Possible from just 200 pieces!

KLEVER.



ATTRIBUTES

Safety	Maximum Safety
Blade Access	4 mm
Cutting Materials	
Other Features	

VPA GS
geprüfte Sicherheit

KLEVER EXCEL

ADD YOUR LOGO - LOW MOQ

Practical, very safe and economical. Then the KLEVER EXCEL is the ideal safety knife for you! Your customers use it to cut and at the same time your branding keeps you at the forefront of their minds! Available in 4 colours, with a choice of 3 cutting heads.

PRODUCT DETAILS

Model	KLEVER EXCEL KCJ-4-20
PRODUCT CODES	KCJ-4-20 + COLOUR
Colours	
Dimensions LxWxH	165 x 35 x 8 mm
Weight	27 g, 31 g
Mounted Blade	KCJ-XH-20
Optional Blades	KCJ-XH-30, KCJ-XH-35
Would you like to print on me?	Possible from just 200 pieces!

KLEVER.



ATTRIBUTES

Safety	Maximum Safety
Blade Access	6 mm
Cutting Materials	
Other Features	

SAFETY CUTTER

ADD YOUR LOGO - LOW MOQ

The SLICE Safety Cutter is a powerful little tool equipped with the world's smallest micro-ceramic blade, designed to cut almost anything while keeping you safe. Keep it on your keychain, fridge, or lanyard at work for safe and convenient package opening. Your customers will use it constantly and at the same time your branding keeps you at the forefront of their minds! The SLICE logo will remain on one side. The other side is branded in this case.

slice®

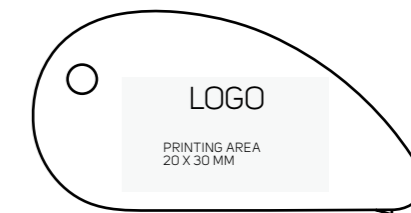

PRODUCT DETAILS

Model	SAFETY CUTTER 00200
PRODUCT CODES	00200
Dimensions LxWxH	61.24 x 30.76 x 5.71 mm
Weight	6 g
Would you like to print on me?	Possible from just 200 pieces!

ATTRIBUTES

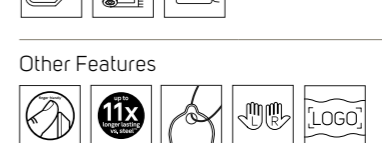
Safety	Maximum Safety
Cutting Depth	2 mm
Cutting Materials	
Other Features	

KLEVER XCHANGE PLUS

ADD YOUR LOGO - LOW MOQ

If you want your promotional product to last a long time, the KLEVER XCHANGE PLUS fits. "Keep the handle, replace the head!" This campaign will never end! Available in 3 colours, with a choice of 3 cutting heads.

PRODUCT DETAILS

Model	KLEVER XCHANGE PLUS PLS-200XC-20
PRODUCT CODES	PLS-200XC-20 + COLOUR
Colours	
Dimensions LxWxH	166 x 33 x 8 mm
Weight	27 g
Mounted blade	KCJ-XH-20
Optional blades	KCJ-XH-30, KCJ-XH-35
Would you like to print on me?	Possible from just 200 pieces!

KLEVER.



ATTRIBUTES

Safety	Maximum Safety
Blade Access	6 mm
Cutting Materials	
Other Features	

POCKET SAFETY CUTTER

ADD YOUR LOGO - LOW MOQ

You always need a practical little Safety knife: in your pocket, handbag, in the car, on the keychain, etc. If it is also attractively printed, your customer will think of you anytime and anywhere! The PSC is available in 3 colours, and has a particularly large print area.

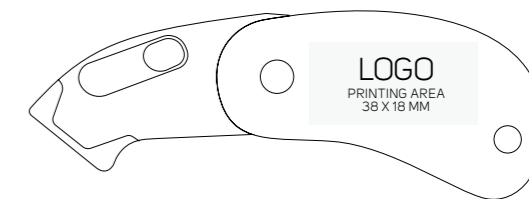

PHC PACIFIC HANDY CUTTER®



PRODUCT DETAILS

Model	Pocket Safety Cutter PSC2
PRODUCT CODES	PSC2 + COLOUR
Colours	
Dimensions LxWxH	104 x 30 x 9 mm
Weight	26 g
Would you like to print on me?	Possible from just 200 pieces!

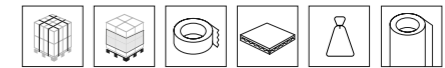
ATTRIBUTES

Safety	High Safety
Cutting Depth	11 mm
Cutting Materials	
Other Features	

AUTO UTILITY SCRAPER

FINGER FRIENDLY BLADE



Tired of dealing with hand strain with your manual scraper? Longing for a blade that doesn't dull after a few uses? The SLICE Auto-Retractable Utility Scraper delivers on all fronts with its finger-friendly edge and ergonomic design. Created to scrape everything but you, the SLICE Auto-Retractable Utility Scraper features soft-touch grips and a sturdy handle for optimal comfort and ease of use. Scrapers typically pose a risk of hand strain, whereas, for this auto-retractable scraper, the SureScrape mechanism absorbs the pressure.

ATTRIBUTES

Safety	Maximum Safety
Blade Width	66 mm

Other Features



PRODUCT DETAILS

Model	10593
PRODUCT CODES	10593
Dimensions LxWxH	136.5 X 73.1 X 22.3 mm
Weight	70.8 g
Available in	1 Unit in Retail Packaging 1 Inner Carton of 6 1 Master Carton of 48



MOUNTED BLADE



Model: 10526
For further Information please see page 95

OPTIONAL BLADES



Model: 10528
For further Information please see page 95

ACCESSORIES



Lanyard: CL-36
For further Information please see page 109

MANUAL UTILITY SCRAPER

FINGER FRIENDLY BLADE



Are you tired of worrying about harming yourself or the quality of your work from using sharp metal scrapers? SLICE is here to help with the only utility scraper on the market that features a safety blade designed to perform the task at hand while protecting you. From its daily use on construction sites to DIY home renovation projects, SLICE makes people and places safer.

ATTRIBUTES

Safety	Maximum Safety
Blade Width	66 mm

Other Features



PRODUCT DETAILS

Model	10591
PRODUCT CODES	10591
Dimensions LxWxH	136.5 X 73.1 X 22.3 mm
Weight	68.5 g
Available in	1 Unit in Retail Packaging 1 Inner Carton of 6 1 Master Carton of 48



MOUNTED BLADE



Model: 10526
For further Information please see page 95

OPTIONAL BLADES



Model: 10528
For further Information please see page 95

ACCESSORIES



Lanyard: CL-36
For further Information please see page 109

LONG HANDLE SCRAPER

FINGER FRIENDLY BLADE



Are you frustrated because your tool can't get to tough-to-reach places? Extend your reach and invest in a scraper that's up to the task with the SLICE Long-Handled Scraper. With its sturdy metal handle and textured grip, it fits comfortably in your hand. The angled blade encourages a natural arm and wrist position to improve ergonomics.

ATTRIBUTES

Safety	Maximum Safety
Blade Width	120 mm

Other Features



ceramic
finger
friendly®



PRODUCT DETAILS

Model	10599
PRODUCT CODES	10599
Dimensions LxWxH	306.5 x 124.5 x 33.5 mm
Weight	298.8 g
Available in	1 Unit in Retail Packaging 1 Inner Carton of 6 1 Master Carton of 24



MOUNTED BLADE

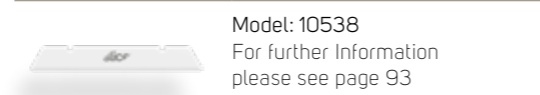

Model: 10538
For further information
please see page 93

OPTIONAL BLADES

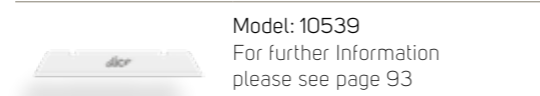

Model: 10539
For further information
please see page 93

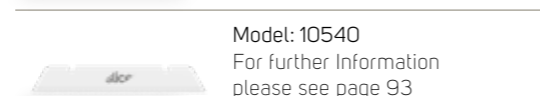

Model: 10540
For further information
please see page 93

SLICE FLOOR SCRAPER

EXTRA LONG STURDY METAL HANDLE WITH TEXTURED GRIP AND FINGER-FRIENDLY BLADE



The SLICE Floor Scraper is the perfect tool for heavy duty surface cleaning. Scraping is easy and comfortable, and its unique finger-friendly blade keeps you safe. The extra long sturdy metal handle with textured grip fits comfortably in your hand, and an angled blade encourages a natural wrist position to minimise discomfort. A blade cover provides additional protection, and the scraper is suitable for left- or right-handed users.

ATTRIBUTES

Safety	Maximum Safety
Blade Width	29 mm

Other Features



ceramic
finger
friendly®



PRODUCT DETAILS

Model	10557
PRODUCT CODES	10557
Dimensions LxWxH	1752.6 x 139.7 x 38.1 mm
Weight	1540 g
Available in	1 Unit in an Inner Carton 1 Master Carton of 10

MOUNTED BLADE

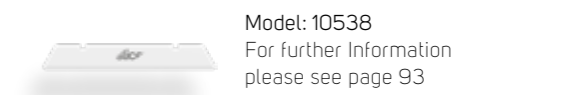

Model: 10538
For further information
please see page 93

OPTIONAL BLADES

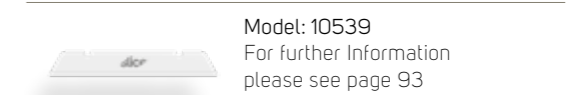

Model: 10539
For further information
please see page 93

WIDE-GRIP SCRAPER

FINGER FRIENDLY BLADE



Trying to get projects done but don't like the feel of a traditional scraper? That's why we created the SLICE Wide-Grip Scraper. With the same power as the traditional scraper, this tool features a comfortable, whole hand grip for easy, efficient scraping, even with gloves. Its blade guard slips off and stores inside the handle for easy access and storage.

ATTRIBUTES

Safety	Maximum Safety
Blade Width	120 mm

Other Features



PRODUCT DETAILS

Model	10501
PRODUCT CODES	10501
Dimensions LxWxH	241.3 x 63.5 x 27.4 mm
Weight	178.5 g
Available in	1 Unit in Retail Packaging 1 Inner Carton of 6 1 Master Carton of 48

MOUNTED BLADE



Model: 10538
For further information please see page 93

OPTIONAL BLADES



Model: 10539
For further information please see page 93



Model: 10540
For further information please see page 93



AUTO-RETRACT SMALL SCRAPER

FINGER FRIENDLY BLADE



Designed to scrape tough-to-reach spaces, the SLICE Auto-Retractable Small Scraper boasts a finger-friendly blade edge. Lightweight and portable. The SureScrape mechanism absorbs kickback resistance, protecting your thumb and lowering your risk of hand strain. Additionally, the blade automatically retracts when you release the slider.



ATTRIBUTES

Safety	Maximum Safety
Blade Width	61 mm

Other Features



PRODUCT DETAILS

Model	10590
PRODUCT CODES	10590
Dimensions LxWxH	63.2 x 67 x 11 mm
Weight	21 g
Mounted blade	10524
Optional Blades	10523, 10525
Accessories	lanyard
Available in	1 Unit in Retail Packaging 1 Inner Carton of 12 1 Master Carton of 192

MANUAL SMALL SCRAPER

FINGER FRIENDLY BLADE



Wish there was a small but mighty scraper that allows you to complete a task without worrying about harming your project or yourself? If you're in the market for a tool that does small-area scraping or includes awkward angles, the SLICE Manual Mini Scraper is the best choice for you. This tool has a durable handle that fits comfortably in your hand and a thin blade that is ideal for tough adhesives or scraping paint and plastic.



ATTRIBUTES

Safety	Maximum Safety
Blade Width	61 mm

Other features



PRODUCT DETAILS

Model	10594
PRODUCT CODES	10594
Dimensions LxWxH	63.2 x 67 x 11 mm
Weight	21 g
Mounted blade	10524
Optional Blades	10523, 10525
Accessories	lanyard
Available in	1 Unit in Retail Packaging 1 Inner Carton of 12 1 Master Carton of 192

METAL SCRAPER

HEAVY DUTY - BRASS SLIDER



The heavy duty all purpose metal scraper is perfect for cleaning glass, scraping paint and a host of other applications. The push button design moves the blade into position and retracts for safe storage. High quality brass slider and eyelet for lanyard fastening or hanging

ATTRIBUTES

Safety	Basic Safety
Blade Width	39 mm

Other Features

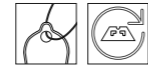

PRODUCT DETAILS

Model	MS-410
PRODUCT CODES	MS-410
Dimensions LxWxH	95 x 45 x 10 mm
Weight	55 g

Available in
 1 Unit in Retail Packaging with 5 spare blades
 1 Bucket of 30
 1 Inner Carton of 50
 1 Master Carton of 200



CSG-22

MOUNTED BLADE



Model: RB-009
 For further information please see page 104

OPTIONAL BLADE



Model: RB-012
 For further information please see page 104



BU-MS-410

LARGE SCISSORS

FINGER FRIENDLY BLADE



ATTRIBUTES

Safety	Maximum Safety
Blade Width	57 mm

Other Features



Large SLICE scissors are perfect for the workplace, kitchen, garden, or craft room. hold them in your hand, and you'll immediately be impressed by everything from the silicone grips to the weighty quality of the ceramic blades. Did we mention they're dishwasher safe?



PRODUCT DETAILS

Model	10545
PRODUCT CODES	10545
Dimensions LxWxH	198 x 75 x 134 mm
Weight	90 g

Available in
 1 Unit in Retail Packaging
 1 Inner Carton of 6
 1 Master Carton of 48



SMALL SCISSORS

FINGER FRIENDLY BLADE

Do you need a pair of scissors that are safe for kids to use while effectively cutting various materials? With a durable nylon handle and soft-touch finger grips, these scissors are perfect for arts and crafts, protecting your little ones from injury while seamlessly cutting multiple materials, including plastic sheeting, string, paper, etc. They're dishwasher-safe, safe enough to clean by hand, and easy to store.



PRODUCT DETAILS

Model	10544
PRODUCT CODES	10544
Dimensions LxWxH	141 x 66.5 x 12.1 mm
Weight	32 g
Available in	1 Unit in Retail Packaging 1 Inner Carton of 6 1 Master Carton of 48

ATTRIBUTES

Safety	Maximum Safety
Blade Width	42 mm

Other Features



SELF OPENING SCISSORS

FINGER FRIENDLY BLADE

SLICE Self-Opening Scissors - a tool with a finger-friendly edge that cuts everything but you. These self-opening scissors are perfect for fiber artists and industrial tailors. Revolutionize the cutting process, appealing to anyone with dexterity challenges, arthritis, or hand weakness. The self-opening function decreases the risk of hand fatigue and overall muscle effort.



ATTRIBUTES

Safety	Maximum Safety
Blade Width	21 mm

Other Features



SMALL POINTED SCISSORS

FINGER FRIENDLY BLADE

From trimming indoor plants and flowers to sewing and crafting. The lightweight, sturdy handle and soft-touch finger loops allow you to cut easily and comfortably. The pointed-tip blades can puncture flexible plastics if you initiate cuts in the middle of the material, or simply to cut herbs for your garden.



PRODUCT DETAILS

Model	10546
PRODUCT CODES	10546
Dimensions LxWxH	132 x 66 x 12.4 mm
Weight	32g
Available in	1 Unit in Retail Packaging 1 Inner Carton of 6 1 Master Carton of 48

ATTRIBUTES

Safety	Maximum Safety
Blade Width	34 mm

Other Features



PRODUCT DETAILS

Model	10595
PRODUCT CODES	10595
Dimensions LxWxH	144 x 182 x 12.2 mm
Weight	24 g
Available in	1 Unit in Retail Packaging 1 Inner Carton of 6 1 Master Carton of 48



ROTARY SCISSORS

FINGER FRIENDLY BLADE

A bladeless tool that goes above and beyond traditional scissors. Particularly lightweight, making them easy to use for an extended period, and boasting a soft-touch grip and ridged thumb rest. This reduces the risk of repetitive strain injuries (RSI) while the tool moves with you. From cutting single sheets off large rolls, to slicing cellophane for retail, SLICE makes people and places safer.



ATTRIBUTES

Safety	Maximum Safety
Blade Width	N/A mm

Other Features



ceramic
finger
friendly®



PRODUCT DETAILS

Model	10598
PRODUCT CODES	10598
Dimensions LxWxH	139 x 68 x 15.2 mm
Weight	68 g
Available in	1 Unit in Retail Packaging 1 Inner Carton of 6 1 Master Carton of 48



INDUSTRIAL BLADES

ROUNDED TIP

SLICE Industrial Blades (Rounded Tip) are compatible with multiple tools, including SLICE Industrial Knives and Wide Scrapers. The longer blade is ideal for making deeper cuts in thicker materials like insulation boards and foam. SLICE blades can withstand wear and tear for longer, resulting in fewer blade changes and injuries.

PRODUCT DETAILS

Model	10538
PRODUCT CODES	10538
Dimensions LxWxH	120.6 x 17.6 x 1.33 mm
Weight	12 g
Compatible with	10559, 10560, 10599
Available in	4 Units in Retail Packaging 1 Inner Carton of 6 Packs 1 Master Carton of 48 Packs



INDUSTRIAL BLADES

POINTED TIP

SLICE Industrial Blades (Pointed Tip) are compatible with SLICE Industrial Knives and Large Scrapers. The extra-long blades are optimal for cutting thick materials, like flexible plastics, insulation boards and foam.

PRODUCT DETAILS

Model	10539
PRODUCT CODES	10539
Dimensions LxWxH	120.6 x 17.6 x 1.33 mm
Weight	12 g
Compatible with	10559, 10560, 10599
Available in	4 Units in Retail Packaging 1 Inner Carton of 6 Packs 1 Master Carton of 48 Packs



INDUSTRIAL BLADES

SERRATED

SLICE Industrial Blades (Serrated) are compatible with SLICE Industrial Knives and Wide Scrapers. The serrated edge is perfect for applications that might require sawing. Whether you're sawing thick foam and insulation or shock absorbers with polyurethane foam, SLICE's serrated industrial blades get the job done safely and effectively.

PRODUCT DETAILS

Model	10540
PRODUCT CODES	10540
Dimensions LxWxH	120.6 x 17.6 x 1.33 mm
Weight	12 g
Compatible with	10559, 10560, 10599
Available in	4 Units in Retail Packaging 1 Inner Carton of 6 Packs 1 Master Carton of 48 Packs



UTILITY BLADES

ROUNDED TIP

SLICE Utility Blades are compatible with several tools, including SLICE Metal-Handle Utility Knives, Small Scrapers, the Edge Utility Cutter, and the EDC Pocket Knife. Designed to cut everything but you, these blades boast a finger-friendly edge that never rusts. The Utility Blades are thinner than typical SLICE blades, making the cutting process a breeze. In addition, the rounded tip is a safer alternative to traditional blades, reducing your risk of injury.

PRODUCT DETAILS

Model	10524
PRODUCT CODES	10524
Dimensions LxWxH	61.8 x 18.8 x 0.78 mm
Weight	3 g
Compatible with	10490, 10491, 10492, 10496, 10590, 10594
Available in	2 Units in Retail Packaging 1 Inner Carton of 6 Packs 1 Master Carton of 48 Packs



slice®



UTILITY KNIFE BLADES

ROUNDED TIP

SLICE Utility Knife Blades are compatible with several tools, including SLICE Utility Knives and Scrapers. Designed to cut everything but you, these blades boast a finger-friendly edge and a rounded tip.

PRODUCT DETAILS

Model	10526
PRODUCT CODES	10526
Dimensions LxWxH	66 x 12.1 x 1.34 mm
Weight	4.61 g
Compatible with	10550, 10554, 10558, 10562, 10585, 10591, 10593
Available in	3 Units in Retail Packaging 1 Inner Carton of 6 Packs 1 Master Carton of 48 Packs



slice®



UTILITY BLADES

POINTED TIP

SLICE Utility Blades (Pointed Tip) are compatible with several tools, including SLICE Metal-Handle Utility Knives and Small Scrapers. Designed to cut everything but you, these blades boast a finger-friendly edge that never rusts. They're also thinner than typical SLICE blades, making the cutting process a breeze.

PRODUCT DETAILS

Model	10525
PRODUCT CODES	10525
Dimensions LxWxH	61.8 x 18.8 x 0.78 mm
Weight	3 g
Compatible with	10490, 10491, 10492, 10496, 10590, 10594
Available in	2 Units in Retail Packaging 1 Inner Carton of 6 Packs 1 Master Carton of 48 Packs



slice®



UTILITY KNIFE BLADES

POINTED TIP

SLICE Utility Knife Blades (Pointed Tip) are compatible with multiple tools, including SLICE Utility Knives, Scrapers, and the Manual Carton Cutter. The pointed tip is perfect for cutting flexible materials – you can initiate the cut with a piercing action.

PRODUCT DETAILS

Model	10528
PRODUCT CODES	10528
Dimensions LxWxH	65.13 x 11.95 x 1.3 mm
Weight	4.67 g
Compatible with	10550, 10554, 10558, 10562, 10585, 10591, 10593
Available in	3 Units in Retail Packaging 1 Inner Carton of 6 Packs 1 Master Carton of 48 Packs



slice®



UTILITY BLADES

SERRATED

SLICE Utility Blades (Serrated) are compatible with multiple tools, including SLICE Metal-Handle Utility Knives. Serrated blades are ideal for applications where a sawing action is preferred.

PRODUCT DETAILS

Model	10523
PRODUCT CODES	10523
Dimensions LxWxH	61.8 x 18.8 x 0.78 mm
Weight	3 g
Compatible with	10490, 10491, 10492, 10496, 10590, 10594
Available in	2 Units in Retail Packaging 1 Inner Carton of 6 Packs 1 Master Carton of 48 Packs



slice®



BOX CUTTER BLADES

ROUNDED TIP

SLICE Box Cutter Blades (Rounded Tip) are compatible with multiple tools, including SLICE Box Cutters, Pen Cutters and Mini Cutters. These blades boast a finger-friendly edge, with the rounded tip adding an extra level of protection against accidental injuries.

PRODUCT DETAILS

Model	10404
PRODUCT CODES	10404
Dimensions LxWxH	3.3 x 6.26 x 1.33mm
Weight	1 g
Compatible with	10400, 10474, 10475, 10495, 10512, 10514
Available in	4 Units in Retail Packaging 1 Inner Carton of 6 Packs 1 Master Carton of 48 Packs



slice®



BOX CUTTER BLADES

POINTED TIP

SLICE Box Cutter Blades (Pointed Tip) are compatible with several tools, including SLICE Box Cutters, Pen Cutters, Mini Cutters, and the EDC Folding Knife. Designed to cut everything but you, these blades boast a finger-friendly edge that never rusts. The pointed tip is ideal for tougher materials – use a piercing action to initiate the cut in the centre of a flexible material like plastic sheeting.

PRODUCT DETAILS

Model	10408
PRODUCT CODES	10408
Dimensions LxWxH	3.3 x 6.26 x 1.33 mm
Weight	0.9 g
Compatible with	10400, 10474, 10475, 10495, 10512, 10514
Available in	4 Units in Retail Packaging 1 Inner Carton of 6 Packs 1 Master Carton of 48 Packs



CRAFT BLADES

STRAIGHT EDGE, ROUNDED TIP

SLICE Craft Blades (Straight Edge, Rounded Tip) are compatible with multiple tools, including SLICE Craft Knives, the Scalpel, and the Precision Knife. Designed to cut everything but you, these blades boast a finger-friendly edge that never rusts. From cutting foam board to creating details in fondant and ceramics, the craft blades are perfect for controlled, precise cuts.

PRODUCT DETAILS

Model	10518
PRODUCT CODES	10518
Dimensions LxWxH	32.6 x 6.2 x 0.82 mm
Weight	0.5 g
Compatible with	10548, 10568, 10580, 10589
Available in	4 Units in Retail Packaging 1 Inner Carton of 6 Packs 1 Master Carton of 48 Packs



DEBURRING BLADE

CONVEX

SLICE Deburring Blade (Convex) is designed specifically for the SLICE Deburring Tool. Featuring a convex design with a curved edge, these blades effortlessly remove burrs and other defects from various materials, from sheet metal and injection-molded plastic to 3D printing, resulting in smooth surfaces and edges.

PRODUCT DETAILS

Model	10483
PRODUCT CODES	10483
Dimensions LxWxH	60 x 15 x 1.8 mm
Weight	7.6 g
Compatible with	10482
Available in	2 Units in Retail Packaging 1 Inner Carton of 6 Packs 1 Master Carton of 48 Packs



CRAFT BLADES

STRAIGHT EDGE, POINTED TIP

SLICE Craft Blades (Straight Edge, Pointed Tip) are compatible with multiple tools, including SLICE craft knives, the Scalpel, and the Precision Knife. Designed to cut everything except you, these blades boast a finger-friendly edge that never rusts. The pointed tip is ideal for intricate, precise cutting. It's perfect for scratchboard or coloured pencil art detail, as well as paper art.

PRODUCT DETAILS

Model	10519
PRODUCT CODES	10519
Dimensions LxWxH	32.6 x 6.2 x 0.82 mm
Weight	0.64 g
Compatible with	10548, 10568, 10580, 10589
Available in	4 Units in Retail Packaging 1 Inner Carton of 6 Packs 1 Master Carton of 48 Packs



DEBURRING BLADE

CONCAVE

SLICE Deburring Blade (Concave) is designed specifically for the SLICE Deburring Tool. Featuring a concave design with a straight, beveled edge, these blades easily remove burrs and other defects from raw edges. The result? A smooth finish on a variety of materials from sheet metal and injection-molded plastic to 3D printing.

PRODUCT DETAILS

Model	10484
PRODUCT CODES	10484
Dimensions LxWxH	60 x 15 x 1.8 mm
Weight	6.9 g
Compatible with	10482
Available in	2 Units in Retail Packaging 1 Inner Carton of 6 Packs 1 Master Carton of 48 Packs



CRAFT BLADES

CURVED EDGE, ROUNDED TIP

SLICE Craft Blades (Curved Edge, Rounded Tip) are compatible with multiple craft tools, including SLICE Craft Knives, the Scalpel, and the Precision Knife. The rounded tip is a safer alternative that reduces the risk of lacerations, while the curved edge adds maneuverability. From cutting vinyl to adding details in fondant and leather, SLICE makes people and places safer.

PRODUCT DETAILS

Model	10520
PRODUCT CODES	10520
Dimensions LxWxH	32.87 x 6.19 x 0.57 mm
Weight	0.52 g
Compatible with	10548, 10568, 10580, 10589
Available in	4 Units in Retail Packaging 1 Inner Carton of 6 Packs 1 Master Carton of 48 Packs



CORNER STRIPPING BLADES

DOUBLE CURVED

SLICE Corner-Stripping Blades are compatible with multiple tools, including SLICE Craft Knives, Scalpel, and Precision Knife. The double-curved edges and pointed tip are optimal for stripping and trimming in tight corners and trimming caulking. The durability of these blades means fewer blade changes and fewer injuries.

PRODUCT DETAILS

Model	10532
PRODUCT CODES	10532
Dimensions LxWxH	33.2 x 6.15 x 0.87 mm
Weight	0.7 g
Compatible with	10548, 10568, 10580, 10589
Available in	4 Units in Retail Packaging 1 Inner Carton of 6 Packs 1 Master Carton of 48 Packs



SEAM RIPPER BLADES

ROUNDED TIP

SLICE Seam Ripper Blades (Rounded Tip) are compatible with multiple tools, including SLICE Seam Rippers, Craft Knives, the Scalpel, and the Precision Knife. The rounded tip offers a safer alternative to traditional seam ripper blades, protecting you and the fabric from accidental punctures while you work. Since these blades never rust, you don't have to worry about damaging your materials with stains. They're safe, effective, and easy to clean.

PRODUCT DETAILS

Model	10536
PRODUCT CODES	10536
Dimensions LxWxH	32.8 x 6.06 x 0.8 mm
Weight	0.37 g
Compatible with	10548, 10568, 10580, 10589, 10596, 10597
Available in	4 Units in Retail Packaging 1 Inner Carton of 6 Packs 1 Master Carton of 48 Packs



CHISEL BLADES

ONE SIDED

SLICE Chisel Blades (one sided) are compatible with crafting tools, including SLICE Craft Knives and Scalpel. These blades boast a finger-friendly edge that never rusts. They're perfect for detailed, precise work, removing small labels, and scraping smaller surfaces. Besides crafting, these chisel blades are great for lab workers and electronics manufacturers due to their non-conductive properties.

PRODUCT DETAILS

Model	10534
PRODUCT CODES	10534
Dimensions LxWxH	32.9 x 8.04 x 0.89 mm
Weight	1.03 g
Compatible with	10548, 10568, 10589
Available in	4 Units in Retail Packaging 1 Inner Carton of 6 Packs 1 Master Carton of 48 Packs



SEAM RIPPER BLADES

POINTED TIP

SLICE Seam Ripper Blades (Pointed Tip) are compatible with multiple tools, including SLICE Seam Rippers, Craft Knives, the Scalpel, and the Precision Knife. The narrow, pointed tip slides easily between stitches, catching and cutting thread without the tugging that damages the surrounding fabric. From removing fine stitches to weeding vinyl, SLICE makes people and places safer.

PRODUCT DETAILS

Model	10537
PRODUCT CODES	10537
Dimensions LxWxH	32.8 x 6.06 x 0.8 mm
Weight	0.69 g
Compatible with	10548, 10568, 10580, 10589, 10596, 10597
Available in	4 Units in Retail Packaging 1 Inner Carton of 6 Packs 1 Master Carton of 48 Packs



CHISEL BLADES

NARROW DOUBLE SIDED

SLICE Chisel Blades (narrow double sided) are compatible with crafting tools, including SLICE Craft Knives and Scalpel. These blades boast a finger-friendly edge that never rusts. They're perfect for detailed, precise work, removing small labels, and scraping smaller surfaces. Besides crafting, these chisel blades are great for lab workers and electronics manufacturers due to their non-conductive properties.

PRODUCT DETAILS

Model	10535
PRODUCT CODES	10535
Dimensions LxWxH	32.9 x 8.04 x 0.89 mm
Weight	0.93
Compatible with	10548, 10568, 10589
Available in	4 Units in Retail Packaging 1 Inner Carton of 6 Packs 1 Master Carton of 48 Packs



PRECISION BLADES

PRECISION IS KEY

SLICE Precision Blades are exclusively compatible with the SLICE Precision Cutters. Designed to cut everything but you, these blades boast a finger-friendly edge that never rusts. Featuring a micro-ceramic tip that's optimal for very thin, precise cutting, perfect for slicing thin materials like paper or vinyl stencils.

PRODUCT DETAILS

Model	10418
PRODUCT CODES	10418
Dimensions LxWxH	27.1 x 5.55 x 5.55 mm
Weight	0.55 g
Compatible with	10416, 10417
Available in	4 Units in Retail Packaging 1 Inner Carton of 6 Packs 1 Master Carton of 48 Packs



BLADE HEAD 20

DOUBLE, CONCEALED BLADE HEAD

20' Double blade head, can be used twice, for KLEVER XCHANGE and KLEVER XCHANGE PLUS safety knives. Especially safe thanks to the concealed blades.

PRODUCT DETAILS

Model	BLADE HEAD 20 KCJ-XH-20
PRODUCT CODES	KCJ-XH-20
Dimensions LxWxH	55 x 34 x 6 mm
Weight	3 g
Compatible with	KLEVER XCHANGE, KLEVER XCHANGE PLUS
Available in	1 Inner Bag of 25 1 Master Carton of 500

KLEVER.



BLADE HEAD 40

DOUBLE CURVED BLADE HEAD

40' Blade head with hook blade. Double usable, therefore particularly economical. With rounded corners. Ideal for cutting bagged goods, carpeting, lining, textiles, string, etc.

PRODUCT DETAILS

Model	BLADE HEAD 40 KCJ-XH-40
PRODUCT CODES	KCJ-XH-40
Dimensions LxWxH	55 x 28 x 6 mm
Weight	3 g
Compatible with	KLEVER XCHANGE, KLEVER XCHANGE PLUS
Available in	1 Inner Bag of 25 1 Master Carton of 500

KLEVER.



BLADE HEAD 30

WIDE CONCEALED BLADE HEAD

30' Blade head with wide mouth, therefore suitable for thicker materials. For safety knives KLEVER XCHANGE and KLEVER XCHANGE PLUS. Especially safe thanks to the concealed blade.

PRODUCT DETAILS

Model	BLADE HEAD 30 KCJ-XH-30
PRODUCT CODES	KCJ-XH-30
Dimensions LxWxH	68 x 49 x 8 mm
Weight	7 g
Compatible with	KLEVER XCHANGE, KLEVER XCHANGE PLUS
Available in	1 Inner Bag of 12 1 Master Carton of 480

KLEVER.



BLADE HEAD 65

DOUBLE CONCEALED BLADE HEAD

65' XD Smooth-Kut Blade head with wide mouth, therefore suitable for thicker materials. For safety knives KLEVER XCHANGE and KLEVER XCHANGE PLUS. Especially safe thanks to the concealed blade.

PRODUCT DETAILS

Model	BLADE HEAD 65 KCJ-XH-65
PRODUCT CODES	KCJ-XH-65
Dimensions LxWxH	67 x 44 x 6 mm
Weight	8 g
Compatible with	KLEVER XCHANGE, KLEVER XCHANGE PLUS
Available in	1 Inner Bag of 25 1 Master Carton of 500

KLEVER.



XD

BLADE HEAD 35

WIDE CONCEALED BLADE HEAD WITH TAPE SPLITTER AND SCRAPER

35' Blade head with wide access, therefore suitable for thicker materials. With scraper and integrated tape splitter. For safety knives KLEVER XCHANGE and KLEVER XCHANGE PLUS. Especially safe thanks to concealed blade.

PRODUCT DETAILS

Model	BLADE HEAD 35 KCJ-XH-35
PRODUCT CODES	KCJ-XH-35
Dimensions LxWxH	68 x 49 x 8 mm
Weight	7 g
Compatible with	KLEVER XCHANGE, KLEVER XCHANGE PLUS
Available in	1 Inner Bag of 12 1 Master Carton of 480

KLEVER.



BLADE HEAD 20X KLEEN

DOUBLE CONCEALED BLADE HEAD

20X Blade head, double usable, in KLEEN antimicrobial version, for safety knives KLEVER XCHANGE KLEEN. Especially safe thanks to concealed blades. Certified according to ISO 22196

PRODUCT DETAILS

Model	BLADE HEAD 20X KLEEN KCJ-XH-20X
PRODUCT CODES	KCJ-XH-20X
Dimensions LxWxH	55 x 34 x 6 mm
Weight	3 g
Compatible with	KLEVER XCHANGE KLEEN
Available in	1 Inner Bag of 25 1 Master Carton of 500

KLEVER.



BLADE HEAD 30X KLEEN

WIDE CONCEALED BLADE HEAD

30X Blade head in KLEEN antimicrobial version, for safety knives KLEVER XCHANGE KLEEN. Especially safe thanks to the concealed blade. Also suitable for thicker materials due to wider blade access. Certified according to ISO 22196

PRODUCT DETAILS

Model	BLADE HEAD 30X KLEEN KCJ-XH-30X
PRODUCT CODES	KCJ-XH-30X
Dimensions LxWxH	68 x 49 x 7 mm
Weight	7 g
Compatible with	KLEVER XCHANGE KLEEN
Available in	1 Inner Bag of 12 1 Master Carton of 480



KLEVER.

BLADE HEAD 35X KLEEN

WIDE CONCEALED BLADE HEAD WITH TAPE SPLITTER AND SCRAPER

35X Blade head, with wide mouth so suitable for thicker materials, in KLEEN antimicrobial version, for safety knives KLEVER XCHANGE KLEEN. Especially safe thanks to concealed blades. Certified according to ISO 22196

PRODUCT DETAILS

Model	BLADE HEAD 35X KLEEN KCJ-XH-35X
PRODUCT CODES	KCJ-XH-35X
Dimensions LxWxH	68 x 49 x 8 mm
Weight	7 g
Compatible with	KLEVER XCHANGE KLEEN
Available in	1 Inner Bag of 12 1 Master Carton of 480



BLADE HEAD 65X KLEEN

WIDE CONCEALED BLADE HEAD WITH TAPE SPLITTER AND SCRAPER

65X XD Smooth-Kut Blade head, with wide mouth so suitable for thicker materials, in KLEEN antimicrobial version, for safety knives KLEVER XCHANGE KLEEN. Especially safe thanks to concealed blades. Certified according to ISO 22196

PRODUCT DETAILS

Model	BLADE HEAD 65X KLEEN KCJ-XH-65X
PRODUCT CODES	KCJ-XH-65X
Dimensions LxWxH	67 x 44 x 6 mm
Weight	8 g
Compatible with	KLEVER XCHANGE KLEEN
Available in	1 Inner Bag of 12 1 Master Carton of 480



XD

HB-8820SS

DOUBLE CURVED BLADE

High-quality stainless steel blade, suitable for the safety knife KS-101SS-W. Can be used on both sides, therefore particularly economical.

PRODUCT DETAILS

Model	HB-8820SS
PRODUCT CODES	HB-8820SS
Dimensions LxWxH	28 x 10 x 0.3 mm
Weight	4 g
Compatible with	KLEVER KS-SERIES KS-101SS-W
Available in	1 Master Carton of 100



BLADE HEAD S5FC

CONCEALED BLADE HEAD

Replacement blade heads with concealed blade, therefore particularly safe. For safety S5 knives.

PRODUCT DETAILS

Model	BLADE HEAD S5FC
PRODUCT CODES	S5FC
Dimensions LxWxH	46 x 30 x 10 mm
Weight	5 g
Compatible with	S5
Available in	1 Inner Bag of 3 1 Master Carton of 216



PHC
PACIFIC HANDY CUTTER™

BLADE HEAD S7FC

CONCEALED BLADE HEAD

Replacement blade heads with concealed blade. For S7 safety knives.

PRODUCT DETAILS

Model	BLADE HEAD S7FC
PRODUCT CODES	S7FC
Dimensions LxWxH	39 x 24 x 9 mm
Weight	3 g
Compatible with	S7
Available in	1 Inner Bag of 3 1 Master Carton of 216



PHC
PACIFIC HANDY CUTTER™

SP1338

USE BOTH SIDES

High-quality blade suitable for the safety cutter EZR. Blade can be used on both sides, therefore particularly economical.



PRODUCT DETAILS

Model	SP1338
PRODUCT CODES	SP1338
Dimensions LxWxH	38 x 9 x 0.2 mm
Weight	4 g
Compatible with	EZR
Available in	1 Inner Carton of 100 60 Inner Cartons of 100



B1117-9

POINTED TIP TRAPEZOID BLADE

Durable carbon steel replacement blade with pointed tip for use with Victa and Metti safety knives. Each box contains 10 dispensers of 10 blades.



PRODUCT DETAILS

Model	INDUSTRIAL UTILITY BLADE, POINTED TIP
PRODUCT CODES	B1117-9
Dimensions LxWxH	50 x 19 x 0.6 mm
Weight	2 g
Compatible with	REBEL
Available in	1 Inner Carton of 100 10 Inner Carton's of 100

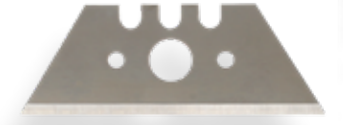

RB009

SINGLE EDGE RAZOR BLADE

Single edge razor blade made from carbon steel. Thickness 0.009" or 0.23mm. Universal fit for many products, including Metal Scraper.



PRODUCT DETAILS

Model	RB009 SINGLE EDGE RAZOR BLADE
PRODUCT CODES	RB009
Dimensions LxWxH	40 x 21 x 1 mm
Weight	2 g
Compatible with	MS410, BUMS410 CSG22 and many other products on the market
Available in	Clamshell of 100 Case of 50 Clamshells



B1118-9

STAINLESS STEEL BLADE

Stainless steel replacement blade with pointed tip for use with Metti MD and Volo MD safety knives. Each box contains 10 dispensers of 10 blades.



PRODUCT DETAILS

Model	INDUSTRIAL UTILITY BLADE, POINTED TIP, STAINLESS STEEL
PRODUCT CODES	B1118-9
Dimensions LxWxH	50 x 19 x 0.6 mm
Weight	2 g
Compatible with	METTI MD, VOLO MD
Available in	1 Inner Carton of 100 10 Inner Carton's of 100



RB012

SINGLE EDGE RAZOR BLADE

Single edge razor blade made from carbon steel. Thickness 0.012" or 0.3mm. Universal fit for many products, including Metal Scraper.



PRODUCT DETAILS

Model	RB012 SINGLE EDGE RAZOR BLADE
PRODUCT CODES	RB012
Dimensions LxWxH	40 x 21 x 1 mm
Weight	2 g
Compatible with	MS410, BUMS410 CSG22 and many other products on the market
Available in	Clamshell of 100 Case of 50 Clamshells



B1119-9

ROUNDED TIP BLADE

Durable carbon steel replacement blade with rounded tip for use with Victa and Metti safety knives. Each box contains 10 dispensers of 10 blades.



PRODUCT DETAILS

Model	HEAVY DUTY UTILITY BLADE, ROUNDED TIP
PRODUCT CODES	B1119-9
Dimensions LxWxH	50 x 19 x 0.6 mm
Weight	2 g
Compatible with	VICTA, METTI
Available in	1 Inner Carton of 100 10 Inner Carton's of 100



B1121-9

INDUSTRIAL UTILITY BLADE ROUNDED TIP

Carbon steel replacement blades with a rounded tip for exclusive use with the PHC Rebel and Volo safety knives.

PRODUCT DETAILS

Model	B1121-9
PRODUCT CODES	B1121-9
Dimensions LxWxH	50 x 19 x 0.6 mm
Weight	2 g
Compatible with	REBEL, VOLO
Available in	1 Inner Carton of 100 10 Inner Carton's of 100



B1122-9

INDUSTRIAL UTILITY BLADE ROUNDED TIP STAINLESS STEEL

Stainless steel replacement blades with a rounded tip for exclusive use with the PHC Metti MD and Volo MD Safety Knives.

PRODUCT DETAILS

Model	B1122-9
PRODUCT CODES	B1122-9
Dimensions LxWxH	50 x 19 x 0.6 mm
Weight	2 g
Compatible with	METTI MD, VOLO MD
Available in	1 Inner Carton of 100 10 Inner Carton's of 100



HB-96

UTILITY BLADES HOOK STYLE

High quality steel hook blade with the universal two-notch design to fit most standard utility knives on the market and are perfect for cutting roofing, linoleum, carpets and much more.

PRODUCT DETAILS

Model	HB-96
PRODUCT CODES	HB-96
Dimensions LxWxH	50 x 19 x 0.6 mm
Weight	3 g
Compatible with	QBS-20
Available in	1 Inner Carton of 100

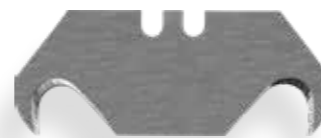

SPD-017

TRAPEZOIDAL BLADE IN SAFETY DISPENSER

High-quality trapezoidal blade in a safety dispenser. 100 pieces per dispenser. Can be used on both sides in many knives, therefore particularly economical. The safety dispenser allows a very simple and safe removal of individual blades via a practical removal drawer. In addition, you can pair the safety dispenser with our blade disposal box. This gives you a practical blade supply and disposal station. Suitable for the safety knives EZAR, RZ3, EZ3, S7, S4S, S5.

PRODUCT DETAILS

Model	SPD-017
PRODUCT CODES	SPD-017 & SP-017
Dimensions LxWxH	Blade: 43 x 19 x 0,63 mm, Dispenser: 115 x 77 x 20 mm
Weight	Blade: 4 g, Dispenser: 235 g
Compatible with	RZ3, EZ3, S7, S4S, S5
Available in	1 Safety Dispenser of 100 1 Master Carton of 12 Safety Dispensers



QBD-324

TRAPEZOIDAL BLADE IN SAFETY DISPENSER

High-quality trapezoidal blade in a safety dispenser (75 pieces per dispenser). Can be used on both sides in multiple knives, therefore particularly economical. The safety dispenser allows the very simple and safe removal of individual blades via a practical removal drawer. In addition, you can pair the safety dispenser with our blade disposal bank. This gives you a practical blade supply and disposal station. Suitable for QBAR, QBS20 and QBA375.

PRODUCT DETAILS

Model	QBD-324
PRODUCT CODES	QBD-324 & SB-92
Dimensions LxWxH	Blade: 62 x 20 x 0,63 mm, Dispenser: 115 x 77 x 20 mm
Weight	Blade: 5 g, Dispenser: 360 g
Compatible with	QBAR, QBS-20, QBA-375
Available in	1 Safety Dispenser of 75 1 Master Carton of 12 Safety Dispensers



QBD-379

ROUNDED TRAPEZOIDAL BLADE IN SAFETY DISPENSER

High-quality trapezoidal blade in a safety dispenser (75 pieces per dispenser). Safety blade with rounded tips to reduce puncture injuries. Can be used on both sides in many knives, therefore particularly economical. The safety dispenser allows the very simple and safe removal of individual blades by a practical removal drawer. In addition, you can pair the safety dispenser with our blade disposal box. This gives you a practical blade supply and disposal station. Suitable for QBAR, QBS20 and QBA375.

PRODUCT DETAILS

Model	QBD-379
PRODUCT CODES	QBD-379 & SPS-92
Dimensions LxWxH	Blade: 58 x 20 x 0,63 mm Dispenser: 115 x 77 x 20 mm
Weight	Blade: 5 g, Dispenser: 360 g
Compatible with	QBAR, QBS-20, QBA-375
Available in	1 Safety Dispenser of 75 1 Master Carton of 12 Safety Dispensers



SP-017

TRAPEZOIDAL BLADE

High-quality trapezoidal blade in a box. 100 pieces per box, 20 tucks of 5 blades. Can be used on both sides in many knives, therefore particularly economical. Proprietary blade suitable for the RZ3, EZ3, S7, S4S and S5 safety knives.

PRODUCT DETAILS

Model	SP-017
PRODUCT CODES	SP-017
Dimensions LxWxH	Blade: 43 x 19 x 0,63 mm,
Weight	Blade: 4 g, Box:
Compatible with	RZ3, EZ3, S7, S4S, S5
Available in	1 Inner Carton of 100 40 Inner Carton's of 100



SB-92

TRAPEZOIDAL BLADE IN BOX

High-quality trapezoidal blade in a box (100 pieces per box, 20 tucks of 5 blades). Can be used on both sides in multiple knives, therefore particularly economical. Standard 92 type blade, suitable for QBAR, QBS20 and QBA375.

PRODUCT DETAILS

Model	SB-92
PRODUCT CODES	SB-92
Dimensions LxWxH	Blade: 62 x 20 x 0,63 mm, Box:
Weight	Blade: 5 g, Box:
Mountable	QBAR, QBS-20, QBA-375
Available in	1 Inner Carton of 100 30 Inner Carton's of 100



SPS-92

ROUNDED TRAPEZOIDAL BLADE IN BOX

High-quality trapezoidal blade in a box (100 pieces per box, 20 tucks of 5 blades) Safety blade with rounded tips to reduce puncture injuries. Can be used on both sides in many knives, therefore particularly economical. Standard 92 type blade suitable for QBAR, QBS20 and QBA375.

PRODUCT DETAILS

Model	SPS-92
PRODUCT CODES	SPS-92
Dimensions LxWxH	Blade: 58 x 20 x 0,63 mm Box:
Weight	Blade: 5 g, Box:
Mountable	QBAR, QBS-20, QBA-375
Available in	1 Inner Carton of 100 30 Inner Carton's of 100



CL-36

LANYARD WITH SPIRAL CORD

Would you like to significantly reduce costs due to the loss of knives? Then our Lanyard CL-36 is for you: stretchy spiral cord, a loop on one end and a 360° carabiner on the other. The lanyard can be attached to almost any of our knives and also fits many belt holsters.

PRODUCT DETAILS

Model	CL-36
PRODUCT CODES	CL-36
Dimensions LxWxH	330 x 13 x 0,3 mm
Weight	11 g
Suitable for	All knives with an eyelet
Available in	1 Inner Bag of 10 1 Inner Bag of 100 1 Master Carton of 500



DFCCON

ADAPTER

The DFCCON is an adaptor that can be threaded onto any 3/4" standard size extension pole to increase employee cutting reach and productivity.

PRODUCT DETAILS

Model	DFCCON
PRODUCT CODES	DFCCON
Dimensions LxWxH	110 x 50 x 20 mm
Weight	40 g
Suitable for	EBC1, EBC1X, DFC-364, DFC364X, DFC364 MD, EZR
Available in	1 Single Unit 1 Inner Bag of 25 1 Master Carton of 100



SLICE HOLSTER

UNIVERSAL BELT HOLSTER

The SLICE Tool Holster boasts five pockets, allowing you to hold everything from the smallest craft knife to the largest utility knife. Its polyester weave design is strong enough to withstand years of use. Use the belt clip to hang it on your belt or trousers, or remove the clip and use the strap on top to hang it anywhere in your workplace.

PRODUCT DETAILS

Model	10516
PRODUCT CODES	10516
Dimensions LxWxH	198 x 75 x 38 mm
Weight	66 g
Suitable for	SLICE SAFETY KNIVES AND MUCH MORE
Available in	1 Inner Carton of 12 1 Master Carton of 48



KLEVER KCJ-HOL

UNIVERSAL BELT HOLSTER

Practical belt holster made of nylon. Suitable for many safety knives, especially of the KLEVER brand. Belt loop with Velcro fastener. One main compartment, a small front compartment with flap and Velcro fastener. So you always have your knife and even spare blade heads on the wearer.

PRODUCT DETAILS

Model	KLEVER KCJ-HOL
PRODUCT CODES	KCJ-HOL
Dimensions LxWxH	175 x 50 x 20 mm
Weight	29 g
Suitable for	KLEVER SAFETY KNIVES AND MUCH MORE
Available in	1 Inner Bag of 10 1 Master Carton of 200



KLEVER.

UKH-671

UNIVERSAL BELT HOLSTER

Practical belt holster made of nylon with loop for belt attachment. The holster also has a convenient pen slot. Suitable for most knives, especially QBA375 and QBS20.

PRODUCT DETAILS

Model	UKH-671
PRODUCT CODES	UKH-671
Dimensions LxWxH	200 x 60 x 40 mm
Weight	35 g
Suitable for	QBA-375 & many more
Available in	1 Inner Bag of 10 1 Master Carton of 100



PHC

PACIFIC HANDY CUTTER®

UKH-423

HOLSTER

Practical belt holster made of plastic with fastening clip for belt or clothing. The knife holder can be swiveled. As a result, a comfortable wearing position can be achieved at any time, whether standing or sitting. Suitable for the safety knife S4S and S5. Particularly easy to clean.

PRODUCT DETAILS

Model	UKH-423
PRODUCT CODES	UKH-423
Dimensions LxWxH	140 x 40 x 25 mm
Weight	35 g
Suitable for	S4S, S5
Available in	10 in an Inner Bag 1 Master Carton of 100



PHC

PACIFIC HANDY CUTTER®

UKH-430

HOLSTER

Practical belt holster made of plastic with fastening clip for belt or clothing. The knife holder can be swiveled. As a result, a comfortable wearing position can be achieved at any time, whether standing or sitting. Suitable for the safety knives EZ-3 and RZ-3. Particularly easy to clean.

PRODUCT DETAILS

Model	UKH-430
PRODUCT CODES	UKH-430
Dimensions LxWxH	140 x 40 x 25 mm
Weight	35 g
Suitable for	EZ3, RZ3
Available in	10 in an Inner Bag 1 Master Carton of 100



PHC

PACIFIC HANDY CUTTER®

UKH-443

HOLSTER

Practical belt holster made of plastic with fastening clip for belt or clothing. The knife holder can be swiveled. As a result, a comfortable wearing position can be achieved at any time, whether standing or sitting. Suitable for the RSC432 safety knife. Particularly easy to clean.

PRODUCT DETAILS

Model	UKH-443
PRODUCT CODES	UKH-443
Dimensions LxWxH	140 x 40 x 25 mm
Weight	35 g
Suitable for	RSC-432
Available in	10 in an Inner Bag 1 Master Carton of 100



PHC

PACIFIC HANDY CUTTER®

UKH-545

HOLSTER

Practical belt holster made of plastic with fastening clip for belt or clothing. The knife holder can be swiveled. As a result, a comfortable wearing position can be achieved at any time, whether standing or sitting. Suitable for the S7 safety knife. Particularly easy to clean.

PRODUCT DETAILS

Model	UKH-545
PRODUCT CODES	UKH-545
Dimensions LxWxH	120 x 33 x 25 mm
Weight	28 g
Suitable for	S7
Available in	10 in an Inner Bag 1 Master Carton of 100



PHC

PACIFIC HANDY CUTTER®

BH-00206

BLADE DISPOSAL BANK WITH WALL BRACKET

Safe cutting also includes safe blade disposal! The blade bank is ideally suited for this. It holds up to 750 used blades and keeps them safe until the filled box is completely disposed of. With the practical bracket and the cable ties included in this version, the bank can be easily attached almost anywhere. Ingenious: The blade bank can be combined our safety blade dispensers to create a useful blade changing station! In clearly visible yellow.

PRODUCT DETAILS

Model	BH-00206
PRODUCT CODES	BH-00206
Dimensions LxWxH	153 x 90 x 90 mm
Weight	143 g
Compatible with	ALL BLADE DISPENSERS
Available in	1 in an Inner Bag 1 Master Carton of 6



Blades sold separately



RETAIL DISPLAY SNAP-OFF KNIVES

75 PIECES

The BK-508 Plastic Snap-Off Knife has a slim lightweight design and is ideal for detailed cutting. The snap-off blade has 13 segments, plus a choice of four havis knife colours.

PRODUCT DETAILS

Model	BK-508
PRODUCT CODES	BK-508
Dimensions LxWxH	170 x 160 x 170 mm
Weight	850 g
Mounted Blade	CSB-32
Accessories	Lanyard
Available in	1 Bucket of 75



ATTRIBUTES

Cutting materials

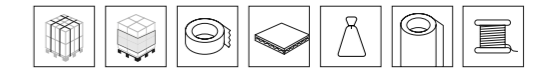

Other features



RETAIL DISPLAY OF METAL SCRAPERS

30 PIECES

The BU-MS-410 is a heavy-duty all purpose Metal Scraper that is perfect for cleaning glass, scraping paint, removing floor wax in corners, and a host of other applications. The push-button moves blade out into position and can be retracted for safe storage.

PRODUCT DETAILS

Model	BU-MS-410
PRODUCT CODES	BU-MS-410
Dimensions LxWxH	170 x 160 x 170 mm
Weight	1800 g
Mounted Blade	RB-009
Accessories	Lanyard
Available in	1 Bucket of 30

ATTRIBUTES

Other features



BB-00205

BLADE DISPOSAL BANK

Safe cutting also includes safe blade disposal! The blade bank is ideally suited for this. It holds up to 750 used blades and keeps them safe until the filled box is completely disposed of. Ingenious: The blade collection box can be combined with our safety blade dispensers to create a useful blade changing station! Comes with two cable ties, So a perfect refill for the bracket version or to use in it's own right. Can be fixed via cable ties to warehouse racking, desk legs etc. In clearly visible yellow.

PRODUCT DETAILS

Model	BB-00205
PRODUCT CODES	BB-00205
Dimensions LxWxH	153 x 90 x 90 mm
Weight	103 g
Compatible with	ALL BLADE DISPENSERS
Available in	1 in an Inner Bag 1 Master Carton of 6



Blades sold separately



RETAIL DISPLAY OF UTILITY KNIVES

18 PIECES

Lightweight plastic utility knife with choice of four havis colours. The standard utility blade included can be replaced.

PRODUCT DETAILS

Model	BU-RPK-394
PRODUCT CODES	BU-RPK-394
Dimensions LxWxH	170 x 160 x 170 mm
Weight	800 g
Mounted Blade	SB-92
Accessories	Belt holster, lanyard
Available in	1 Bucket of 18



ATTRIBUTES

Cutting materials

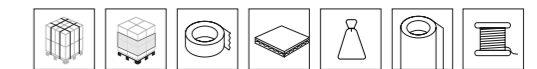

Other features



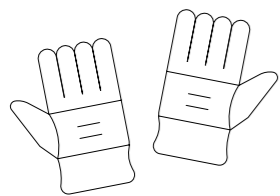

FIRST THINGS FIRST

Always ensure a secure footing. If possible, wear gloves. Even if our knives are already very safe, the gloves protect you during your other activities. A safety knife is designed to cut. Please do not use it for leverage, as a hammer, or for other unsuitable actions. You could injure yourself and damage the knife.

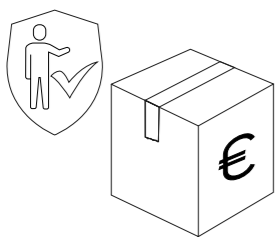

PROTECTION OF PERSONS AND GOODS

PROTECTION OF THE USER: PRICELESS! GOODS PROTECTION: NOT QUANTIFIABLE!

- Due to multiple protection mechanisms, a safety knife reduces the risk of personal injury
- Always carefully select the best and safest knife for your application. We are happy to help!
- Our three security levels also give you guidance
- Choose the highest level of safety with which you can do your job.
- Even a shortened blade reduces the risk of injury. Choose the blade length as required for your cutting activity
- Many of our blades have rounded tips to reduce the risk of puncture.

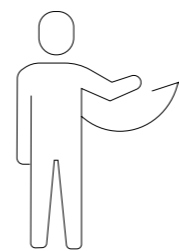

ALWAYS CUT AWAY FROM THE BODY!!

Your body should never be inline, rather always offset to the material that you are cutting. If possible, cut away from the body, otherwise at least past the body. Choose a safe stance. Your free hand should never be in the cutting path! By the way, a fresh, sharp steel blade is always safer than a blunt steel blade because you can only use a blunt steel blade with extra force. Sharp steel blades use little force and you can cut in a controlled manner.

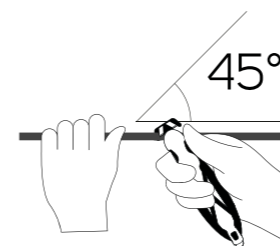

45° ANGLE

LESS FORCE = EASIER WORK = LESS RISK OF INJURY

- When cutting corrugated cardboard, tilt the knife slightly sideways. This significantly reduces the necessary force.
- Always cut strapping at a 45° angle. As a result, the strap is cut easily and with little force.
- Ensure that films and tapes are always taught, before you cut them. The blade cuts up your material better!

TYPES OF CUTTING

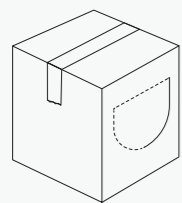

WINDOW SECTION

A window is cut into a cardboard box, to remove goods in a targeted manner

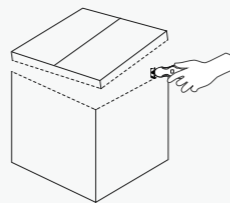

BOX TOPPING

Remove the top of the box completely. Especially comfortable with all safety knives with guard, e. g. S 4 and S 7.

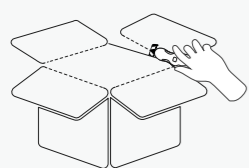

OPEN TABS

Cut off the 4 opened tabs. Put the box on the shelf or the display in a targeted manner.



ROLLED GOODS

Material is usually under pressure when cutting from a roll. These are usually high force cuts. Choose one of our robust Knives.

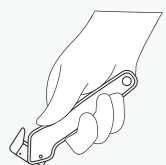

TAPE SPLITTER

Many of our safety knives have an integral tape splitter. With it, you can easily split adhesive tape. This protects the blade life and prevents adhesive residue from depositing on your blade.

CUTTING MATERIALS



Strapping



Corrugated cardboard



Rubber



Film and Foil



Bagged goods



PVC, felt, textile



Adhesive tape



Rolled goods



Yarn, string

OTHER FEATURES



Tape Splitter



Blade change



Printable



Eyelet for lanyard



Easy cleaning



Antimicrobial



Right & left-handed



Disposable



Metal Detectable



NSF Food Zone



Finger-Friendly



Eco-Friendly



Made in USA



Lasts up to 11x longer

WHY ACCEPT LESS?

We help you to select the right safety knife. Because our customers should buy out of conviction. This catalogue provides you with a first overview. But of course we advise you in person, on the phone, by e-mail, video call or at your site. A detailed workplace analysis is a matter of course for us and helps your team select the right safety knives. We of course stand by to support, even after the purchase, with training and advice at any time.

SAFETY PRODUCTS
GLOBAL

slice **KLEVER** **PHC**
PACIFIC HAZARD CUTTER

Safety Products Holdings GmbH
International office for Safety Products Global
for EMEA and APAC

Beuler Höhe 16-18 ☎ +49 (0) 2324 54630-00
45525 Hattingen ✉ info@safetyproductsholdings.com
Germany 🌐 www.safetyproductsholdings.com



Our safety knives and all other products have been developed using state-of-the-art technology and meet the highest standards in terms of workmanship and materials. At the same time, intelligent technologies make our products particularly safe. Nevertheless, despite all the protective mechanisms, these knives can still pose a risk, not only if they are used incorrectly. Our blades - including safety blades and finger-friendly ceramic blades - are first and foremost blades and cut. Therefore, please handle all our products with great care and caution. Modifications are not permitted, can cause hazards and invalidate any warranty.

We hope you enjoy using our safety knives at all times - always a cut above!